



Mobil Plastic[®]

**Catalogo
Generale
2023**



MOBIL PLASTIC S.P.A.

Catalogo Generale

Indice

Catalogo 2023



FERRAMENTA & MAGAZZINO
HARDWARE & STORAGE

9



BRICOLAGE & FAI DA TE
DO IT YOURSELF

50



PULIZIA &
RACCOLTA DIFFERENZIATA
CLEANING & WASTE COLLECTION

70



ENOLOGIA & AGRICOLTURA
ENOLOGY & AGRICULTURE

98



TRASPORTO LIQUIDI &
INDUSTRIA ALIMENTARE
LIQUID TRANSPORT & FOOD INDUSTRY

112



CASALINGHI
HOUSEHOLD

134

Mobil Plastic®

Dove siamo

Mobil Plastic®

Via Robbio 31,
27030 Confienza (PV)
ITALIA

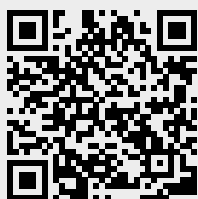

Google Map



Shoot and go !

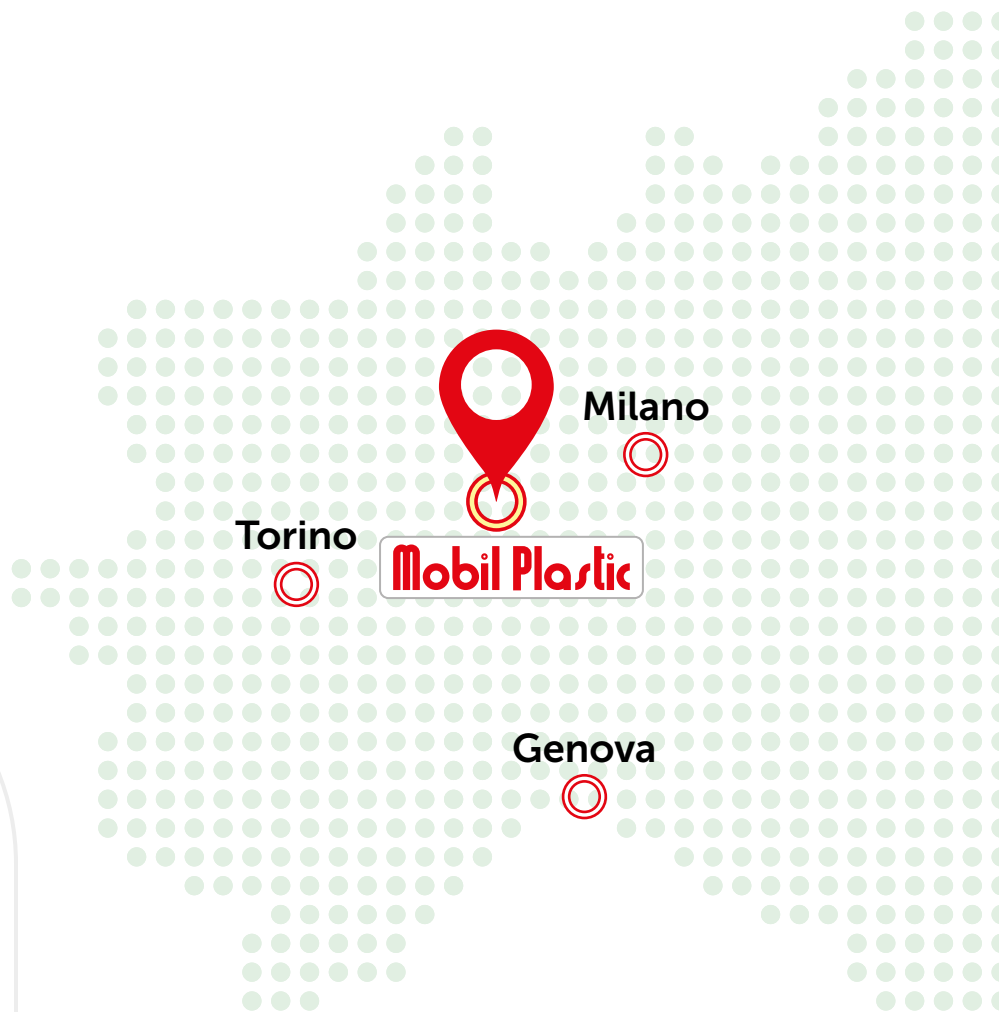

COME RAGGIUNGERCI

Mobil Plastic s.p.a. è ubicata in località CONFIENZA (PV) a ca. 15 km da Novara, Vercelli e Mortara.

In posizione strategica rispetto alle grandi linee di comunicazione, la si può raggiungere sia dalla A4 (Torino – Venezia) uscita Novara Est, che dalla A21 (Piacenza – Torino) uscita Voghera, che dalla A26 (Gravellona – Voltri) uscita Vercelli Est.

HOW TO REACH US

Mobil Plastic s.p.a. is located in CONFIENZA (PV) about 15 km from Novara, Vercelli and Mortara.

In a strategic position with respect to the main transport network, it can be reached either from the A4 (Turin-Venice) Novara Est exit or from the A21 (Piacenza-Turin) Voghera exit or from the A26 (Gravellona-Voltri) Vercelli Est exit.



Venezia

Bologna

ROMA

About



1968

Verso la fine degli anni '60, gli anni che hanno segnato la storia industriale dell'Italia, e più precisamente nel 1968, viene fondata l'azienda Mobil Plastic.

Fin dai primi anni il successo è stato immediato, prima in Italia, per poi espandersi nei mercati europei di riferimento con la presenza a tutte le Fiere Internazionali più importanti del settore.

In the late '60s and more precisely in 1968, years that marked the industrial history in Italy, Mobil Plastic started its activity. Since the early years, the company has made an instant success, first of all in Italy and then also in the most important European markets, attending all the best known international exhibitions in its sector.



1997

Nel pieno della sua continua espansione, nel 1997 avviene il passaggio generazionale alla guida della società. Subentrano infatti i figli del fondatore, Alberto e Pierangelo, i quali fin da subito pongono le basi per una ulteriore crescita applicando una rinnovata politica aziendale unitamente a moderne strategie commerciali.

Nuove ed innovative tecnologie di produzione ed una attenta e mirata ricerca e diversificazione, consentono, pochi anni dopo, l'apertura di una nuova unità produttiva all'estero.

In 1997, in the middle of its continuous expansion, the company generational handover took place. The founder's sons, Alberto and Pierangelo, chose to follow an updated company policy together with new business strategies. Few years later, thanks to new production technologies, a focused research and diversification approaches, Mobil Plastic started a new production unit abroad.

2008

Il 2008 segna una ulteriore ed importante svolta con l'acquisizione di una storica azienda Italiana molto conosciuta con il marchio SSS, attiva da oltre 40 anni nel settore casalingo, enologico, industriale e più di recente anche nel settore ecologico.

L'importante investimento vede raddoppiare le dimensioni aziendali e i volumi di produzione imponendo alla società Mobil Plastic nuovi obiettivi, nuove strategie e nuove sfide commerciali.

2008 marks a further important turning point thanks to the takeover of a well-known Italian company famous for the "SSS" brand, which has worked for more than 40 years in the enology, households, industrial and, more recently, eco-friendly sector.

This important investment doubles the company dimensions and the production volumes, imposing to Mobil Plastic new goals, new strategies and new business challenges.



2018

Mobil Plastic compie 50 anni ed è sempre più una realtà leader nel suo settore merceologico. E' affermata in tutta Europa con lo spirito dell'innovazione, di nuovi processi produttivi, del web e dei nuovi mercati; si apre una nuova era e nasce la nuova immagine della società in linea con i tempi. Ancora una volta, Mobil Plastic pone le basi per una ulteriore evoluzione e crescita e si propone al mercato come "partner" serio, affidabile e moderno.

Mobil Plastic celebrates 50 years of activity and nowadays it is a leading company on its market. It is a well-known company all over Europe thanks to its spirit of innovation, its tendency for new production processes, web market and other sectors. This is the beginning of a new era with a contemporary and up-to-date corporate image.

2022

Anni difficili, di pandemia che stravolgono le abitudini, i valori e le regole dei mercati in tutto il mondo.

Mobil Plastic ancora una volta si distingue per versatilità, resilienza e reattività ai cambiamenti consolidando e crescendo ulteriormente.

Nuovi importanti investimenti in linea con le direttive INDUSTRIA 4.0 e la ricerca e l'utilizzo di nuove tecnologie e processi produttivi con materie prime GREEN a basso impatto. Mobil Plastic guarda al futuro con sano ottimismo, consapevole del proprio know how e pronta ad affrontare ed ad imporsi ai mercati di riferimento in tutta Europa

Difficult years, years of pandemics that upset the habits, values and rules of markets all over the world. Mobil Plastic once again stands out for its versatility, resilience and reactivity to changes, consolidating and growing further.

New important investments in line with the INDUSTRY 4.0 directives and the research and use of new technologies and production processes with low-impact GREEN raw materials.

Mobil Plastic looks to the future with healthy optimism, aware of its know-how and ready to face and impose itself on the reference markets throughout Europe

Ambiente

Mobil Plastic per l'Ambiente

Mobil Plastic è impegnata in prima linea investendo in risorse e tecnologie per sostenere una filiera produttiva e logistica volta a salvaguardare, tutelare e rispettare l'ambiente e il mondo che ci circonda. Largo utilizzo di materie prime provenienti da POST CONSUMO, riciclate e riciclabili al 100% rendono i prodotti Mobil Plastic a basso impatto ambientale e in linea con una concezione "GREEN" seguendo e applicando direttive delle principali organizzazioni mondiali sull'ambiente e più in generale su concetti di "Economia circolare". Anche gli approvvigionamenti da fornitori esterni sono controllati e scelti accuratamente in base al concetto di "KM 0" per diminuire al massimo il trasporto e l'inquinamento ambientale. Materiali di nuova applicazione per il settore dello stampaggio ad iniezione sono utilizzati da Mobil Plastic, come ad esempio il "PET" proveniente dalla filiera del riciclo bottiglie di plastica. Mobil Plastic garantisce per ogni singolo suo prodotto, la massima attenzione alla qualità, alla durata e alla produzione a basso impatto ambientale.

Autonomia Energetica

Grazie ai nostri impianti fotovoltaici siamo in grado di generare autonomamente buona parte dell'energia necessaria alla nostra produzione, risparmiando così preziose risorse ambientali senza inquinare.

Mobil Plastic è Corporate Golden Donor FAI

Mobil Plastic è membro Corporate Golden Donor FAI, associazione conosciuta in tutto il mondo. Essere membro Corporate Golden Donor FAI è segno di eccellenza ed è un modo concreto per contribuire ad una causa importante che Mobil Plastic abbraccia da anni con entusiasmo.

Mobil Plastic for the Environment

Mobil Plastic is committed to the forefront by investing in resources and technologies to support a production and logistics chain aimed at safeguarding, protecting and respecting the environment and the world around us. Wide use of raw materials from POST-CONSUMPTION, recycled and 100% recyclable, make Mobil Plastic products with low environmental impact and in line with a "GREEN" concentration, following and applying directives from world organizations on the environment and more generally on concepts of "Circular Economy". Even supplies from external suppliers are controlled and chosen on the basis of the "KM 0" concept to minimize transport and environmental pollution. Newly applied materials for the injection molding sector are used by Mobil Plastic, such as "PET" from the plastic bottle recycling chain. Mobil Plastic guarantees for each single product, the utmost attention to quality, duration and production with low environmental impact.

Energy Independence

Thanks to our photovoltaic systems, we are able to generate electricity, thus saving environmental resources.

Mobil Plastic is Corporate Golden Donor FAI

Mobil Plastic is a FAI Corporate Golden Donor, association known all over the world. To be a FAI Corporate Golden Donor is a sign of excellence and gives a concrete contribution to an important cause that Mobil Plastic has joined for years with enthusiasm.



FAI

CORPORATE
GOLDEN
DONOR

Noi sosteniamo il FAI

Certificazione 100% GREEN

Tutti gli articoli a catalogo Mobil Plastic contraddistinti da questo simbolo, sono realizzati con materie prime riciclabili o riciclate da post consumo.



Certificate 100% GREEN

All items on Mobil Plastic catalog, marked with this symbol, are made with recyclable or post-consumer recycled raw materials.

Certificazione plastica seconda vita

Il marchio "PLASTICA SECONDA VITA" (PSV) viene assegnato dall'Istituto IPPR (Istituto Promozione Plastiche Riciclo) dopo attente analisi e procedure.

Si tratta di un sistema di certificazione ambientale dei prodotti ottenuti dal riciclo di rifiuti plastici domestici e post-industriali.

Tale certificazione PSV, la prima in ambito Europeo, esprime un concetto di qualità e rintracciabilità dei materiali impiegati, con riferimento al DM attuativo 203/2003 relativo al GREEN PUBLIC PROCUREMENT e alle normative di riferimento.

Mobil Plastic, anche attraverso il riconoscimento ottenuto di PSV, persegue l'obiettivo di produzione a BASSO IMPATTO AMBIENTALE utilizzando materie prime riciclate da prodotti già utilizzati e contribuendo ad alimentare il ciclo di ECONOMIA CIRCOLARE.

Tutti gli articoli a catalogo MOBIL PLASTIC contraddistinti dal simbolo PSV - plastica 2° vita sono realizzati con materiali idonei e conformi alla certificazione dell'Istituto IPPR ed immessi sul mercato rispettando tutte le normative di riferimento in ambito comunitario e Italiano

Certificate second life plastic

The "SECOND LIFE PLASTIC" (PSV) brand is assigned by the IPPR institute (the Italian institute for the promotion of plastic recycling) after a thorough check and procedures. It is an environmental certification system for products obtained from the recycling of domestic and post-industrial plastic waste.

This PSV certification, the first in Europe, expresses a concept of quality and traceability of the materials used, according to the implementing Ministerial Decree 203/2003 relating to green public procurement and the relevant regulations. Mobil Plastic, also through the certification obtained by PSV, pursues the goal of lowest environmental impact production using recycled raw materials from products that have already been used and helping to feed the circular economy cycle.

All the items in the MP catalogue marked with the "PSV - second life plastic" symbol are made with suitable materials and comply with the IPPR institute certification and placed on the market in compliance with all the relevant regulations in Italy and in the European Community.

 plastica
seconda vita
MIX ECO

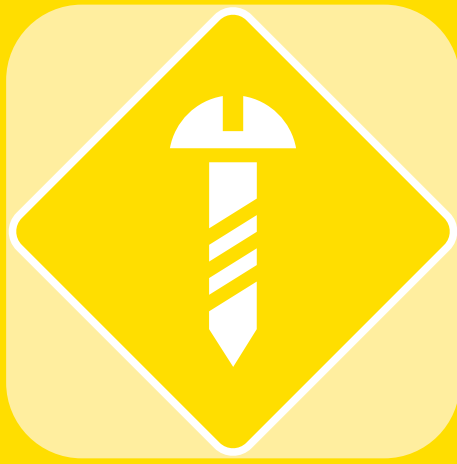

10



Serie 2000

12



Serie C500

14



Serie KOMBI

20



CRYSTAL BOX

FERRAMENTA & MAGAZZINO

Hardware & Storage

38



MINI

40



MIDI

42



MAXI



FERRAMENTA & MAGAZZINO

Hardware & Storage



Serie 2000 contenitori sovrapponibili in HPDE

| art | L | H | P | Capacità Capacity | Imballo pezzi Pack quantity |
|--------|-----|-----|-----|----------------------|--------------------------------|
| 2001 | 103 | 55 | 90 | 0,4 l | 100 |
| 2001/B | 103 | 62 | 120 | 0,7 l | 100 |
| 2002 | 103 | 83 | 165 | 1 l | 48 |
| 2002/L | 103 | 83 | 240 | 2 l | 28 |
| 2003 | 145 | 125 | 240 | 3,5 l | 38 |
| 2003/L | 145 | 125 | 335 | 6 l | 16 |
| 2004 | 207 | 165 | 345 | 10 l | 20 |
| 2005 | 303 | 190 | 485 | 30 l | 12 |
| 2005/S | 363 | 250 | 580 | 52 l | 4 |

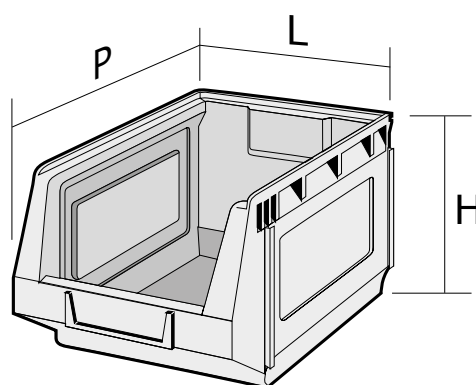

Coperchio SERIE 2000



Coperchio
trasparente per
2001



Coperchio
trasparente per
2001/B



Coperchio
trasparente per
2002



PRODOTTI IN
MATERIALE
RICICLABILE



Plastic®



2001



2001/B



2002



2002/L



2003



2003/L



2004



2005



2005/S



PRODOTTI IN
MATERIALE
RICICLABILE



**FERRAMENTA &
MAGAZZINO**
Hardware & Storage

Serie C500

contenitori sovrapponibili
e componibili in HPDE

| art | L | H | P | Capacità Capacity | Imballo pezzi Pack quantity |
|---------|-----|-----|-----|----------------------|--------------------------------|
| C 502 | 105 | 85 | 163 | 1 l | 48 |
| C 503 | 150 | 125 | 240 | 3,5 l | 38 |
| C 504 | 212 | 165 | 345 | 10 l | 24 |
| C 505 | 305 | 190 | 485 | 30 l | 12 |
| C 505/S | 370 | 250 | 580 | 52 l | 4 |

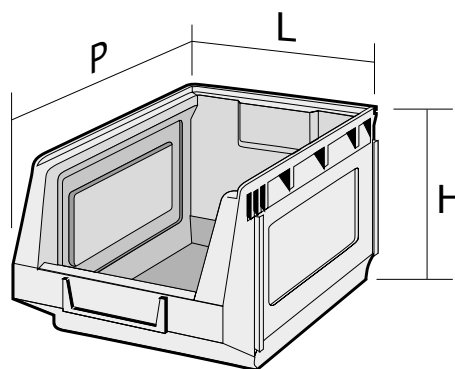

Componibili ad incastro laterale

Side interlocking system

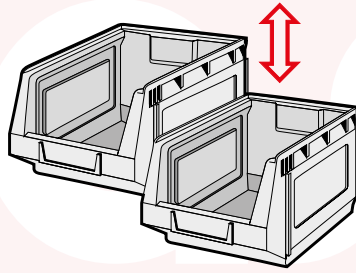

C 502



C 503



C 504



C 505



C 505/S



PRODOTTI IN
MATERIALE
RICICLABILE

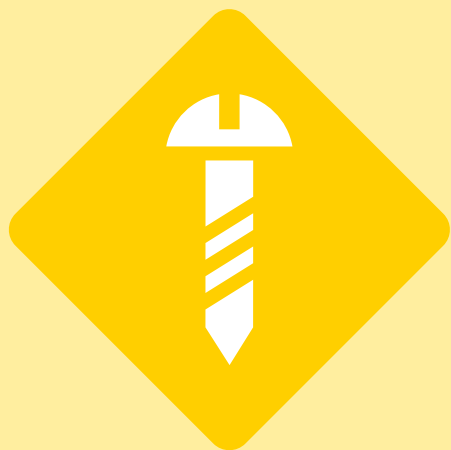

**FERRAMENTA &
MAGAZZINO**
Hardware & Storage



Serie KOMBI

contenitori sovrapponibili
e componibili in PST AU

| art | L | H | P | Capacità Capacity | Imballo pezzi Pack quantity |
|-------|-----|-----|-----|----------------------|--------------------------------|
| 1 PST | 103 | 53 | 95 | 0,4 l | 100 |
| 2 K | 108 | 75 | 167 | 1 l | 48 |
| 3 K | 151 | 128 | 240 | 3,5 l | 38 |
| 3 KB | 296 | 128 | 240 | 7 l | 24 |
| 3 KBD | 296 | 128 | 240 | 7 l | 24 |
| 4 K | 213 | 165 | 350 | 10 l | 24 |
| 5 K | 310 | 190 | 490 | 30 l | 12 |
| 5 KD | 310 | 190 | 490 | 30 l | 12 |
| 5 KS | 385 | 250 | 580 | 52 l | 4 |
| 5 KSD | 385 | 250 | 580 | 52 l | 4 |
| 6 K | 450 | 300 | 710 | 95 l | 4 |
| 6 KD | 450 | 300 | 710 | 95 l | 4 |

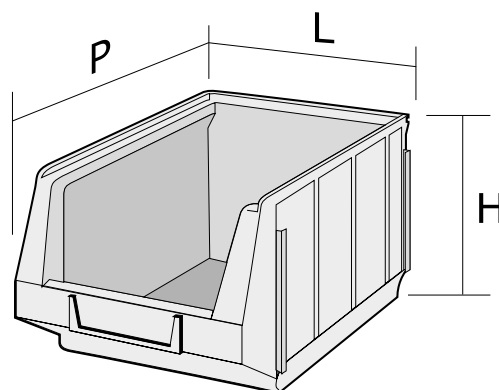

Componibili ad incastro laterale e posteriore
Back and side interlocking system

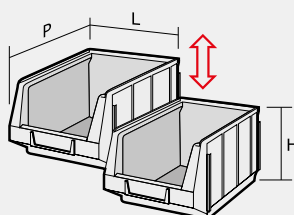

2 K - 3 K - 3 KB - 3 KBD - 4 K - 5 K
5 KD 5 KS - 5 KSD - 6 K - 6 KD

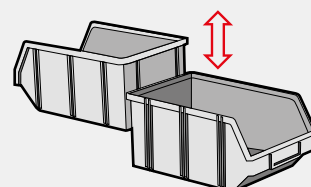

3 KB - 3 KBD - 4 K - 5 K - 5 KD
5 KS - 5 KSD - 6 K - 6 KD



1 PST



2 K



3 K



3 KB



3 KBD



4 K



5 K



5 KD



5 KS



5 KSD



6 K



6 KD



PATELETTA 4 K - 5 K



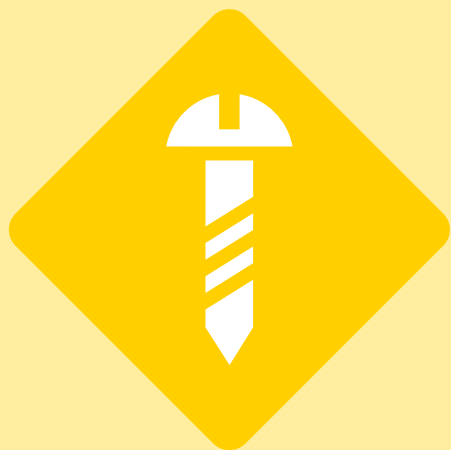

PENSIL

pannelli pensili serie 2000

Pannelli flangiati portacontenitori in robusta lamiera stampata, verniciati a forno in polvere epossidica di colore rosso.

Flanged panel for bins constructed of sheet steel, epoxy powder coating.

**FERRAMENTA &
MAGAZZINO**
Hardware & Storage

| art | L | H | P | Imballo Pezzi Pack quantity |
|-------|-------|-----|----|--------------------------------|
| MP 90 | 1.000 | 455 | 15 | 2 |
| MP 45 | 495 | 455 | 15 | 2 |

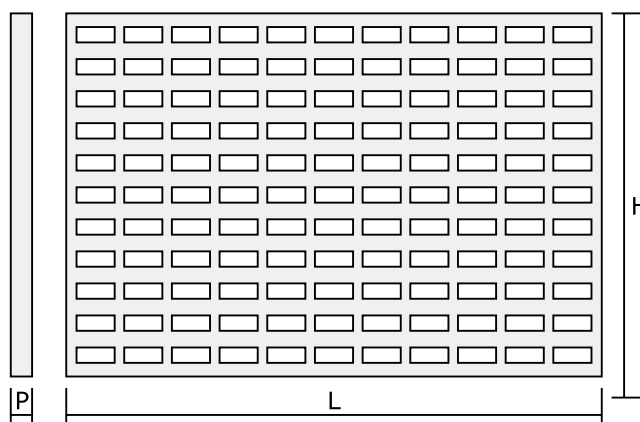
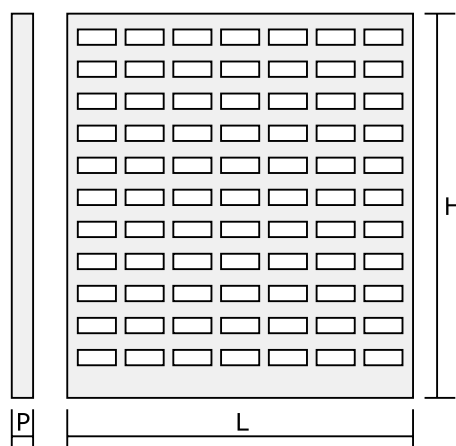

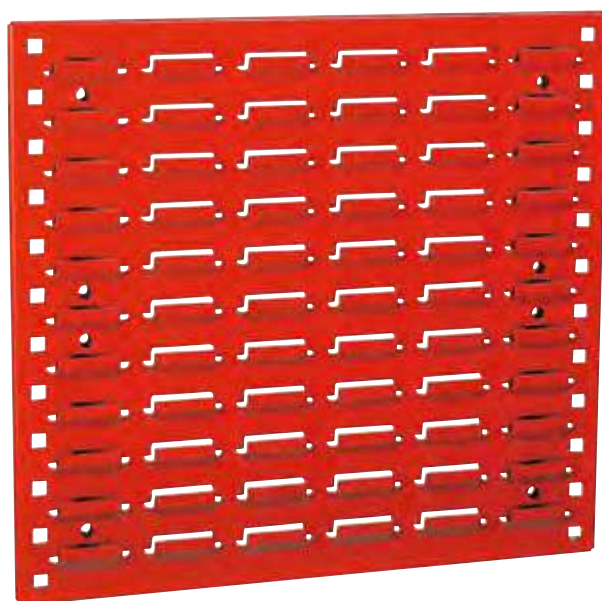

MP 45

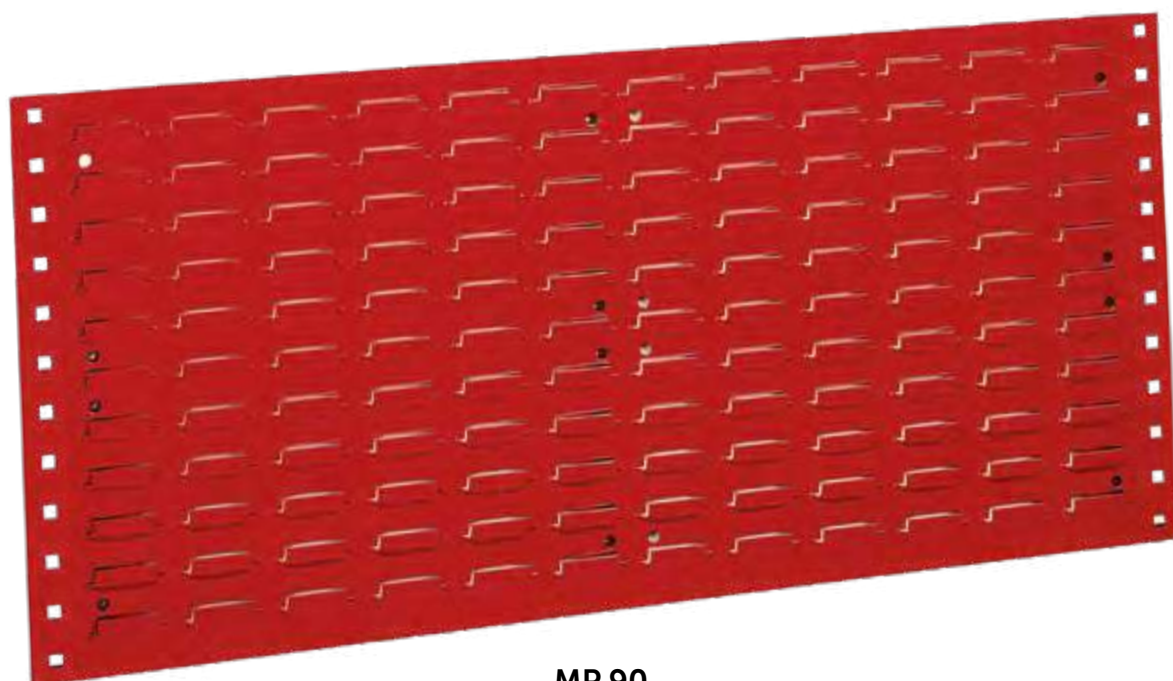

MP 90



CARRELLI portacontenitori serie 2000

Robusti e pratici carrelli per esigenze di magazzino mobile. Realizzati in lamiera elettrosaldata e verniciati a forno in polvere epossidica di colore rosso. Dotati di n. 4 ruote gommatae di cui 2 piroettanti (una con fermo). Forniti smontati con schema e minuterie per l'assemblaggio.

Strong and practical trolleys for mobile storage. Made of electro-welded plate and oven painted with red epoxy powder. Equipped with nr. 4 gummed wheels, 2 of them are pirouetting (1 with brake). Supplied disassembled with a handbook, screw and bolts for assembly.

**FERRAMENTA &
MAGAZZINO**
Hardware & Storage



| art | L | H | P | Imballo Pezzi Pack quantity |
|---------|-------|-------|-----|--------------------------------|
| MP 30/C | 610 | 1.300 | 610 | 1 |
| MP 60 | 1.060 | 1.300 | 610 | 1 |

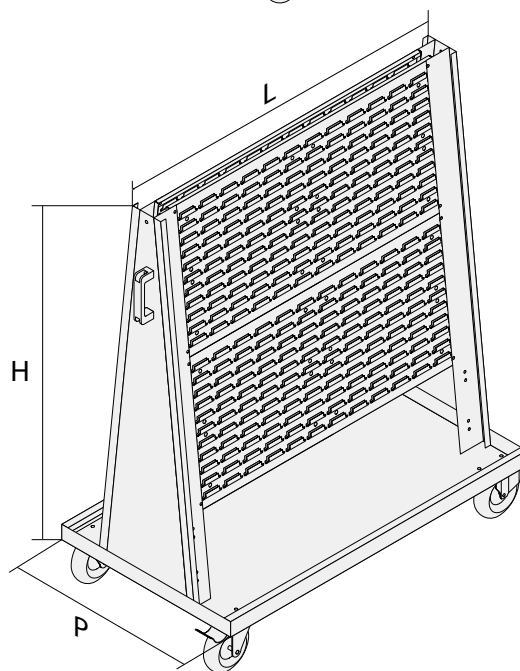
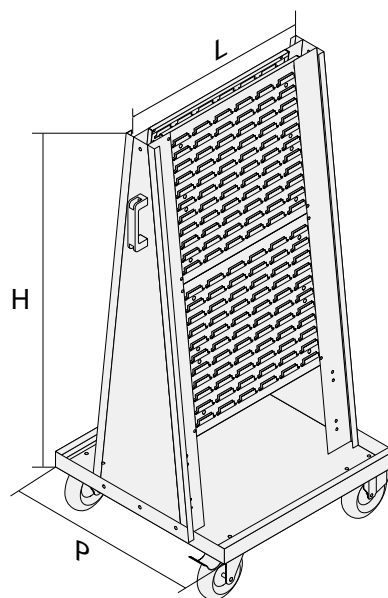

* KIT CONTENITORI SERIE 2000

KIT MP 30/C

Totale numero contenitori: 60

Total number of bins: 60

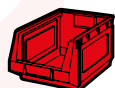

2003=
n.12



2002=
n.32



2001=
n.16

KIT MP 60

Totale numero contenitori: 120

Total number of bins: 120

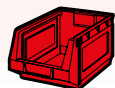

2003=
n.24



2002=
n.64



2001=
n.32

- * Ordinabili separatamente
- * To be order separately



MP 30/C
(prodotto privo di contenitori)
(item supplied without bins)



MP 60
(prodotto privo di contenitori)
(item supplied without bins)



CRYSTAL BOX

cassettiere

Cassetti

Realizzati in PET (Polietilene tereftalato), infrangibili, proprietà antistatiche, resistenti ad agenti chimici aggressivi e ad oli e acidi, elevata resistenza agli urti e al peso, assoluta trasparenza immutata nel tempo, idonei al contatto con sostanze alimentari. Utilizzabile da -50° a +150°

Drawers

Made of PET (polyethylene terephthalate), shatterproof, with antistatic properties, resistant to aggressive chemical agents, oils and acids, shockproof and high weight resistance, total drawer transparency unchanged over time, suitable for food contact. Working temperatures from -50° to +150°.

Struttura esterna

Realizzata in Compound di Polipropilene con elevate caratteristiche di resistenza al carico. Totale assenza di spigoli e sensazione "soft touch" al tatto.

Case

High load resistance thanks to Polypropylene compound. No edges and soft touch surface.

**FERRAMENTA &
MAGAZZINO**
Hardware & Storage



Connettore posteriore (solo per CB 50/3) ed etichette adesive in dotazione standard.
Rear connector (only for CB 50/3) and standard labels included.



Fermo per Crystal Box.
Locking bar for Crystal Box.



●
GS
(SIMIL RAL 7016)



●
GC
(SIMIL RAL 7035)



●
BL
(SIMIL RAL 5017)

| Art. | DESCRIZIONE DESCRIPTION | L x P x H |
|----------|---|---|
| CB 50/2S | Crystal Box - 5 cassetti Crystal Box - 5 drawers | STRUTTURA ESTERNA - CASE: 600 x 133 x 132 CASSETTO - DRAWER: 90 x 86 x 62 |
| CB 50/3 | Crystal Box - 1 cassetto Crystal Box - 1 drawer | STRUTTURA ESTERNA - CASE: 300 x 155 x 175 CASSETTO - DRAWER: 255 X 107 X 105 |
| CB 50/3S | Crystal Box - 3 cassetti Crystal Box - 3 drawers | STRUTTURA ESTERNA - CASE: 600 x 155 x 175 CASSETTO - DRAWER: 160 X 107 X 105 |
| CB 50/4S | Crystal Box - 3 cassetti Crystal Box - 3 drawers | STRUTTURA ESTERNA - CASE: 600 x 200 x 215 CASSETTO - DRAWER: 165 x 140 X 105 |
| CB 50/5S | Crystal Box - 2 cassetti Crystal Box - 2 drawers | STRUTTURA ESTERNA - CASE: 600 x 240 x 300 CASSETTO - DRAWER: 258 X 190 X 165 |



CB 50/2S

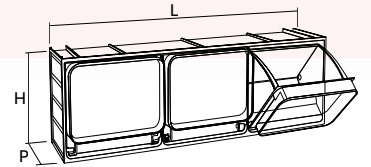

CB 50/3



VASCB50/2S.TR



CB 50/3S



VASCB50/3S.TR



CB 50/4S

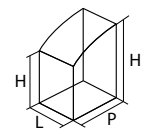

CB 50/5S

| art | L | H | P |
|---|----|---------|-----|
| VASCB50/2S.TR Vaschetta per CB50/2S | 48 | 60/95 | 88 |
| VASCB50/3S.TR Vaschetta per CB50/3S | 77 | 102/140 | 105 |

Ogni cassetto CB50/2S
o CB50/3S può contenere
2 vaschette estraibili.

Each drawer CB50/2S
o CB50/3S can contain
2 removable cups.

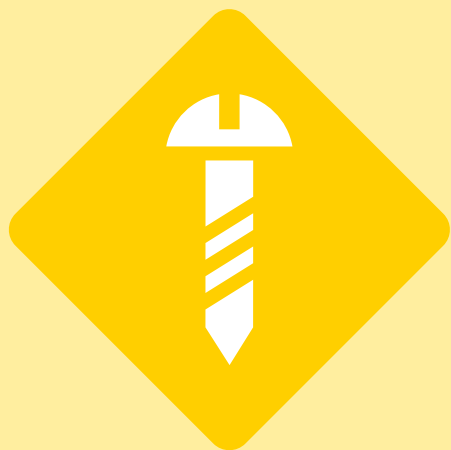

CRYSTAL BOX

telai

MP 100

Pratico telaio da banco o da parete. Realizzato in lamiera elettrosaldata e verniciato a forno in polvere epossidica.

MP 100

Practical frame for bench or wall. Made of epoxy powder coated electro-welded sheet.

MP 125

Robusto telaio per fissaggio a parete. Realizzato in lamiera elettrosaldata e verniciato a forno in polvere epossidica.

MP 125

Strong wall mounted frame. Made of epoxy powder coated electro-welded sheet.

MP 195 - MP 175 - MP 150

Pratici e robusti telai espositori con base. Realizzati in lamiera elettrosaldata e verniciati a forno in polvere epossidica. Forniti smontati con viteria per assemblaggio.

MP 195 - MP 175 - MP 150

Practical and strong frame with base. Made of epoxy powder coated electro-welded sheet.

FERRAMENTA & MAGAZZINO

Hardware & Storage



Esempio di allestimento

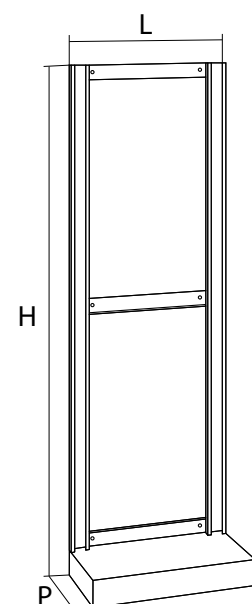
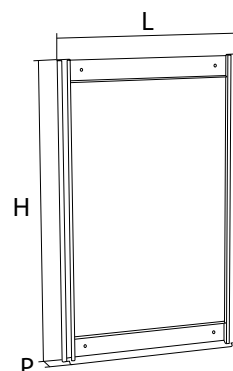
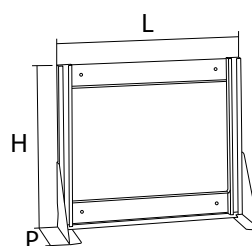

| Art. | DESCRIZIONE DESCRIPTION | L x P x H |
|--------|---|----------------------------------|
| MP 100 | espositore da banco per Crystal Box. <i>shelf display for Crystal Box.</i> | 610 x 150 x 500 |
| MP 125 | espositore pensile per Crystal Box. <i>wall mounted frame for Crystal Box.</i> | 605 x 40 x 1.000 |
| MP 150 | espositore con base per Crystal Box. <i>frame with base for Crystal Box.</i> | 605 x 250 x 1.500 UTILE 1.400 |
| MP 175 | espositore con base per Crystal Box. <i>frame with base for Crystal Box.</i> | 605 x 250 x 1.750 UTILE 1.650 |
| MP 195 | espositore con base per Crystal Box. <i>frame with base for Crystal Box.</i> | 605 x 250 x 1.950 UTILE 1.850 |



MP 195



MP 175



MP 150



MP 100



MP 125



Esempio di incastro cassettiere Crystal Box su telaio espositore.
Instructions to set up a frame with Crystal Box.

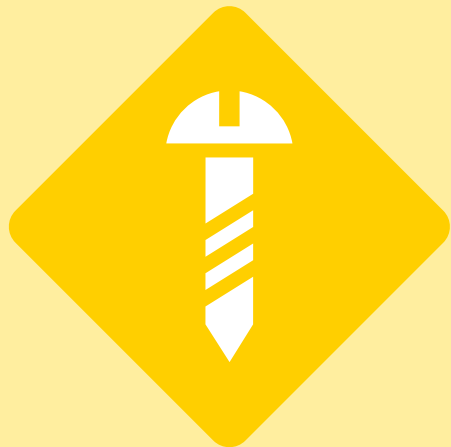

SCAFFALI

Robusto scaffale in lamiera elettrosaldata.

Consente l'allineamento frontale delle cassettiere Crystal Box.
Verniciato a forno in polvere epossidica RAL 7035.
Fornito già montato.

Strong frame made of electro-welded plate.

*All Crystal Box drawers are frontally aligned.
Oven painted with epoxy powder RAL 7035.
Supplied assembled.*

FERRAMENTA & MAGAZZINO

Hardware & Storage

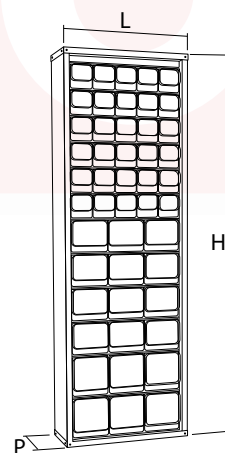

CB 200



GS • (SIMIL RAL 7016)
(CASSETTI - DRAWERS)



GC • (SIMIL RAL 7035)
(CASSETTI - DRAWERS)



BL • (SIMIL RAL 5017)
(CASSETTI - DRAWERS)

●
Ral 7035
(STRUTTURA - FRAME)

| Art. | DESCRIZIONE DESCRIPTION | L x P x H |
|----------|---|---------------------|
| CB 200 | scaffale con 30 cassetti. (4 CB50/4S + 6 CB50/3S) shelf with 30 drawers. (4 CB50/4S + 6 CB50/3S) | 665 x 250 x 2.000 |
| CB 200A | scaffale con 48 cassetti. (2 CB50/4S + 4 CB50/3S + 6 CB50/2S) shelf with 48 drawers. (2 CB50/4S + 4 CB50/3S + 6 CB50/2S) | 665 x 250 x 2.000 |
| CB 200D | scaffale con 60 cassetti. (8 CB50/4S + 12 CB50/3S) shelf with 60 drawers. (8 CB50/4S + 12 CB50/3S) | 1.260 x 250 x 2.000 |
| CB 200DA | scaffale con 96 cassetti. (4 CB50/4S + 8 CB50/3S + 12 CB50/2S) shelf with 96 drawers. (4 CB50/4S + 8 CB50/3S + 12 CB50/2S) | 1.260 x 250 x 2.000 |



CB 200A



CB 200D



STRUTTURA ESTERNO CASSETTIERE
CASE



CASSETTI E VASCHE
DRAWERS AND CUPS



PRODOTTI IN
MATERIALE
RICICLABILE



CRYSTAL BOX

armadi CB 400/1

Armadio a pannelli scorrevoli su cuscinetti a sfera.

Struttura con n. 2 pannelli fissi affiancati sul fondo + n. 1 scorrevole, realizzata in lamiera elettrosaldada con barre di rinforzo. Verniciata a forno con polvere epossidica. Fornito smontato con manuale di assemblaggio e viteria. Portata singolo pannello: kg 160 circa. Ruote e perni silenziati in nylon.

Cabinet with sliding panels on balls bearing.

Frame equipped with n. 2 fixed panels placed side by side on the bottom + n. 1 sliding panel, made of electrowelded reinforced plate. Made of epoxy powder coated electro-welded sheet. Supplied disassembled with a handbook for assembly and screw and bolts. Load capacity of each panel: 160 kg about. Silent running nylon rollers and pins.

FERRAMENTA & MAGAZZINO

Hardware & Storage



CB 400/1
(90 cassetti - drawers)

- Pannello fisso con n. 10 CB50/3S + n. 10 CB50/3S.
Fixed panel with n. 10 CB50/3S + n. 10 CB50/3S.
- Pannello scorrevole con n. 10 CB50/3S.
Sliding panel with n. 10 CB50/3S.

**Due pannelli fissi
Un pannello scorrevole**
Two fixed panels
One sliding panel



CB 400/1A
(130 cassetti - drawers)

- Pannello fisso con n. 10 CB50/3S + n. 10 CB50/3S.
Fixed panel with n. 10 CB50/3S + n. 10 CB50/3S.
- Pannello scorrevole con n. 14 CB50/2S.
Sliding panel with n. 14 CB50/2S.

**Due pannelli fissi
Un pannello scorrevole**
Two fixed panels
One sliding panel



CB 400/1B
(210 cassetti - drawers)

- Pannello fisso con n. 14 CB50/2S + n. 14 CB50/2S.
Fixed panel with n. 14 CB50/2S + n. 14 CB50/2S.
- Pannello scorrevole con n. 14 CB50/2S.
Sliding panel with n. 14 CB50/2S.

**Due pannelli fissi
Un pannello scorrevole**
Two fixed panels
One sliding panel

| Art. | PANNELLI FISSI FIXED PANELS | PANNELLO SCORREVOLE SLIDING PANEL | TOT CASSETTI TOTAL DRAWERS | L x P x H |
|-----------|--------------------------------|--------------------------------------|-------------------------------|---------------------|
| CB 400/1 | 10 CB50/3S + 10 CB50/3S | 10 CB50/3S | 90 | 1.270 x 400 x 1.950 |
| CB 400/1A | 10 CB50/3S + 10 CB50/3S | 14 CB50/2S | 130 | 1.270 x 400 x 1.950 |
| CB 400/1B | 14 CB50/2S + 14 CB50/2S | 14 CB50/2S | 210 | 1.270 x 400 x 1.950 |



Luce LED
per armadio CB 400
LED light for CB 400

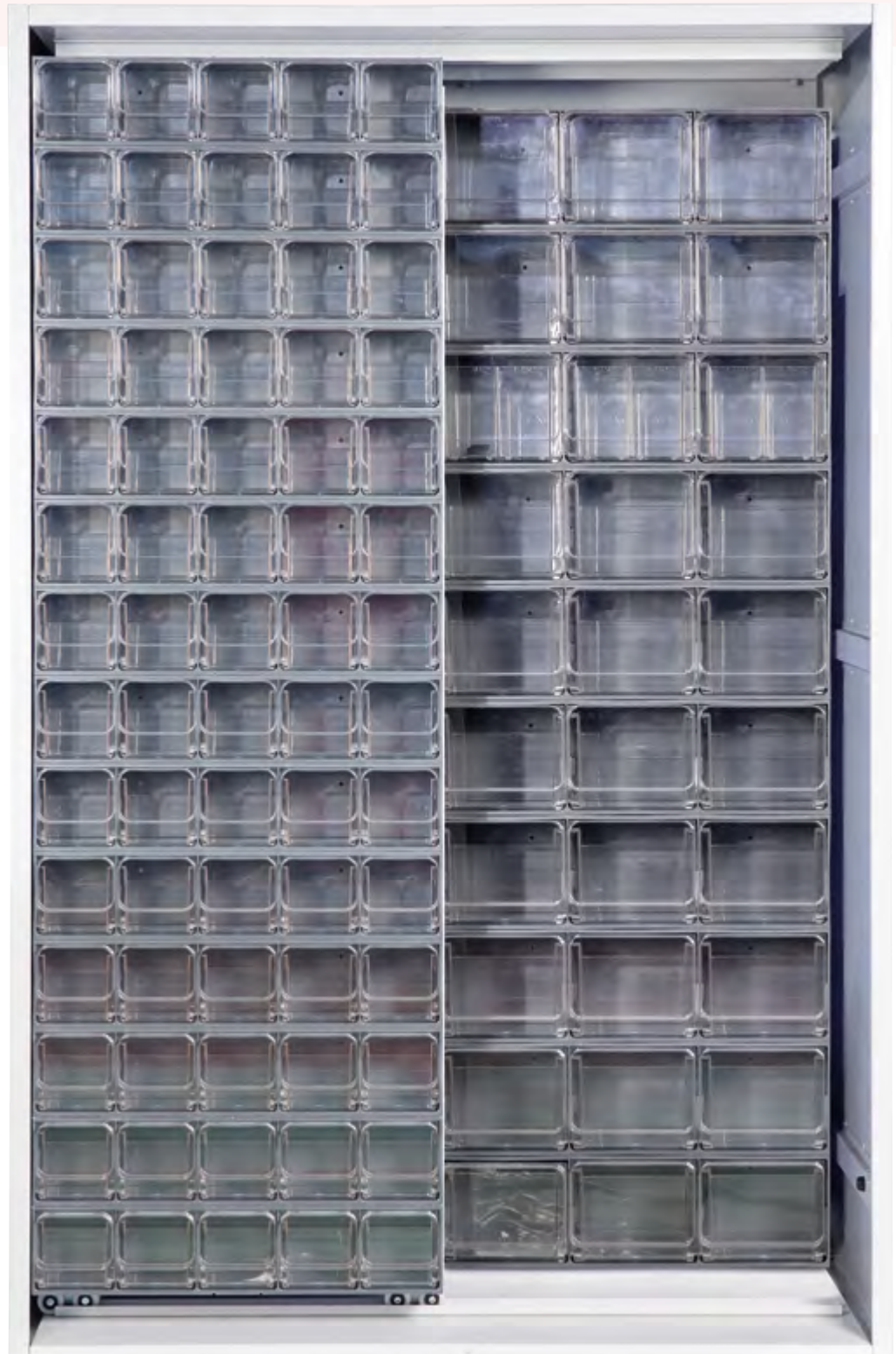

Esempio
CB 400/1A



CRYSTAL BOX

armadi CB 400/2

Armadio a pannelli scorrevoli su cuscinetti a sfera.

Struttura con n. 2 pannelli fissi affiancati sul fondo + n. 2 scorrevoli, realizzata in lamiera elettrosaldata con barre di rinforzo. Verniciata a forno con polvere epossidica. Fornito smontato con manuale di assemblaggio e viteria. Portata singolo pannello: kg 160 circa. Ruote e perni silenziati in nylon.

Cabinet with sliding panels on balls bearing.

Frame equipped with n. 2 fixed panels placed side by side on the bottom + n. 2 sliding panels, made of electrowelded reinforced plate. Made of epoxy powder coated electro-welded sheet. Supplied disassembled with a handbook for assembly and screw and bolts. Load capacity of each panel: 160 kg about. Silent running nylon rollers and pins.

FERRAMENTA & MAGAZZINO

Hardware & Storage



CB 400/2
(120 cassetti - drawers)

- Pannello fisso con n. 10 CB50/3S + n. 10 CB50/3S.
Fixed panel with n. 10 CB50/3S + n. 10 CB50/3S.
- Pannello scorrevole con n. 10 CB50/3S.
Sliding panel with n. 10 CB50/3S.
- Pannello scorrevole con n. 10 CB50/3S.
Sliding panel with n. 10 CB50/3S.

Due pannelli fissi
Due pannelli scorrevoli
Two fixed panels
Two sliding panels



CB 400/2A
(154 cassetti - drawers)

- Pannello fisso con n. 10 CB50/4S + n. 8 CB50/3S.
Fixed panel with n. 10 CB50/4S + n. 8 CB50/3S.
- Pannello scorrevole con n. 10 CB50/3S.
Sliding panel with n. 10 CB50/3S.
- Pannello scorrevole con n. 14 CB50/2S.
Sliding panel with n. 14 CB50/2S.

Due pannelli fissi
Due pannelli scorrevoli
Two fixed panels
Two sliding panels



CB 400/2B
(200 cassetti - drawers)

- Pannello fisso con n. 10 CB50/3S + n. 10 CB50/3S.
Fixed panel with n. 10 CB50/3S + n. 10 CB50/3S.
- Pannello scorrevole con n. 14 CB50/2S.
Sliding panel with n. 14 CB50/2S.
- Pannello scorrevole con n. 14 CB50/2S.
Sliding panel with n. 14 CB50/2S.

Due pannelli fissi
Due pannelli scorrevoli
Two fixed panels
Two sliding panels

| Art. | PANNELLI FISSI FIXED PANELS | PANNELLO SCORR. POST. REAR SLIDING PANELS | PANNELLO SCORR. ANT. SLIDING FRONT PANEL | TOT CASSETTI TOTAL DRAWERS | L x P x H |
|-----------|--------------------------------|--|---|-------------------------------|---------------------|
| CB 400/2 | 10 CB50/3S + 10 CB50/3S | 10 CB50/3S | 10 CB50/3S | 120 | 1.270 x 600 x 1.950 |
| CB 400/2A | 10 CB50/4S + 8 CB50/3S | 10 CB50/3S | 14 CB50/2S | 154 | 1.270 x 600 x 1.950 |
| CB 400/2B | 10 CB50/3S + 10 CB50/3S | 14 CB50/2S | 14 CB50/2S | 200 | 1.270 x 600 x 1.950 |



Luce LED
per armadio CB 400
LED light for CB 400



Esempio
CB 400/2A

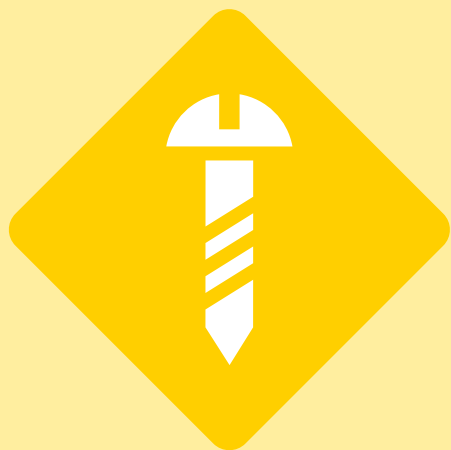

CRYSTAL BOX

armadi CB 400/3

Armadio a pannelli scorrevoli su cuscinetti a sfera.

Struttura con n. 2 pannelli fissi affiancati sul fondo + n. 3 scorrevoli, realizzata in lamiera elettrosaldada con barre di rinforzo. Verniciata a forno con polvere epossidica. Fornito smontato con manuale di assemblaggio e viteria.

Portata singolo pannello: kg 160 circa.

Ruote e perni silenziati in nylon.

Cabinet with sliding panels on balls bearing.

Frame equipped with n. 2 fixed panels placed side by side on the bottom + n. 3 sliding panels, made of electrowelded reinforced plate. Made of epoxy powder coated electro-welded sheet. Supplied disassembled with a handbook for assembly and screw and bolts. Load capacity of each panel: 160 kg about. Silent running nylon rollers and pins.

FERRAMENTA & MAGAZZINO

Hardware & Storage



CB 400/3
(144 cassetti - drawers)

Pannello fisso con n. 10 CB50/4S + n. 8 CB50/3S.
Fixed panel with n. 10 CB50/4S + n. 8 CB50/3S.

Pannello scorrevole post. con n. 10 CB50/3S.
Sliding panel with n. 10 CB50/3S.

Pannello scorrevole mediano con n. 10 CB50/3S.
Sliding panel with n. 10 CB50/3S.

Pannello scorrevole ant. con n. 10 CB50/3S.
Sliding panel with n. 10 CB50/3S.

**Due pannelli fissi
Tre pannelli scorrevoli**

**Two fixed panels
Three sliding panels**



CB 400/3A
(150 cassetti - drawers)

Pannello fisso con n. 10 CB50/3S + n. 10 CB50/3S.
Fixed panel with n. 10 CB50/3S + n. 10 CB50/3S.

Pannello scorrevole post. con n. 10 CB50/3S.
Sliding panel with n. 10 CB50/3S.

Pannello scorrevole mediano con n. 10 CB50/3S.
Sliding panel with n. 10 CB50/3S.

Pannello scorrevole ant. con n. 10 CB50/3S.
Sliding panel with n. 10 CB50/3S.

**Due pannelli fissi
Tre pannelli scorrevoli**

**Two fixed panels
Three sliding panels**



CB 400/3B
(224 cassetti - drawers)

Pannello fisso con n. 10 CB50/4S + n. 8 CB50/3S.
Fixed panel with n. 10 CB50/4S + n. 8 CB50/3S.

Pannello scorrevole post. con n. 10 CB50/3S.
Sliding panel with n. 10 CB50/3S.

Pannello scorrevole mediano con n. 14 CB50/2S.
Sliding panel with n. 14 CB50/2S.

Pannello scorrevole ant. con n. 14 CB50/2S.
Sliding panel with n. 14 CB50/2S.

**Due pannelli fissi
Tre pannelli scorrevoli**

**Two fixed panels
Three sliding panels**



CB 400/3C
(270 cassetti - drawers)

Pannello fisso con n. 10 CB50/3S + n. 10 CB50/3S.
Fixed panel with n. 10 CB50/3S + n. 10 CB50/3S.

Pannello scorrevole post. con n. 14 CB50/2S.
Sliding panel with n. 14 CB50/2S.

Pannello scorrevole mediano con n. 14 CB50/2S.
Sliding panel with n. 14 CB50/2S.

Pannello scorrevole ant. con n. 14 CB50/2S.
Sliding panel with n. 14 CB50/2S.

**Due pannelli fissi
Tre pannelli scorrevoli**

**Two fixed panels
Three sliding panels**

| Art. | PANNELLI FISSI FIXED PANELS | PANN. SCORR. POST. REAR SLIDING PANELS | PANN. SCORR. MEDIANO REAR SLIDING PANELS | PANN. SCORR. ANT. SLIDING FRONT PANEL | TOT CASSETTI TOT. DRAWERS | L x P x H |
|-----------|--------------------------------|---|---|--|------------------------------|---------------------|
| CB 400/3 | 10 CB50/4S + 8 CB50/3S | 10 CB50/3S | 10 CB50/3S | 10 CB50/3S | 144 | 1.270 x 800 x 1.950 |
| CB 400/3A | 10 CB50/3S + 10 CB50/3S | 10 CB50/3S | 10 CB50/3S | 10 CB50/3S | 150 | 1.270 x 800 x 1.950 |
| CB 400/3B | 10 CB50/4S + 8 CB50/3S | 10 CB50/3S | 14 CB50/2S | 14 CB50/2S | 224 | 1.270 x 800 x 1.950 |
| CB 400/3C | 10 CB50/3S + 10 CB50/3S | 14 CB50/2S | 14 CB50/2S | 14 CB50/2S | 270 | 1.270 x 800 x 1.950 |



Luce LED
per armadio CB 400
LED light for CB 400



Esempio
CB 400/3B



STRUTTURA ESTERNO CASSETTIERE
CASE



CASSETTI E VASCHE
DRAWERS AND CUPS



PRODOTTI IN
MATERIALE
RICICLABILE



CRYSTAL BOX

armadi CB 600/4

Armadio a pannelli scorrevoli su cuscinetti a sfera.

Struttura con n. 3 pannelli fissi affiancati sul fondo + n. 4 scorrevoli, realizzata in lamiera elettrosaldada con barre di rinforzo. Verniciata a forno con polvere epossidica. Fornito smontato con manuale di assemblaggio e viteria.

Portata singolo pannello: kg 160 circa.

Ruote e perni silenziati in nylon.

Cabinet with sliding panels on balls bearing.

Frame equipped with n. 3 fixed panels placed side by side on the bottom + n. 4 sliding panels, made of electrowelded reinforced plate. Made of epoxy powder coated electro-welded sheet. Supplied disassembled with a handbook for assembly and screw and bolts. Load capacity of each panel: 160 kg about. Silent running nylon rollers and pins.

FERRAMENTA & MAGAZZINO

Hardware & Storage



CB 600/4
(201 cassetti - drawers)

- Pannello fisso con n. 5 CB50/4S + n. 4 CB50/3S x tre pannelli.
Fixed panel with n. 5 CB50/4S + n. 4 CB50/3S x three panels.
- Pannello scorrevole posteriore con n. 10 CB50/3S + n. 10 CB50/3S.
Sliding panel with n. 10 CB50/3S + n. 10 CB50/3S.
- Pannello scorrevole anteriore con n. 10 CB50/3S + n. 10 CB50/3S.
Sliding panel with n. 10 CB50/3S + n. 10 CB50/3S.

| | |
|---|---|
| Tre pannelli fissi Quattro pannelli scorrevoli | Three fixed panels Four sliding panels |
|---|---|



CB 600/4A
(210 cassetti - drawers)

- Pannello fisso con n. 10 CB50/3S + n. 10 CB50/3S + n. 10 CB50/3S.
Fixed panel with n. 10 CB50/3S + n. 10 CB50/3S + n. 10 CB50/3S.
- Pannello scorrevole posteriore con n. 10 CB50/3S + n. 10 CB50/3S.
Sliding panel with n. 10 CB50/3S + n. 10 CB50/3S.
- Pannello scorrevole anteriore con n. 10 CB50/3S + n. 10 CB50/3S.
Sliding panel with n. 10 CB50/3S + n. 10 CB50/3S.

| | |
|---|---|
| Tre pannelli fissi Quattro pannelli scorrevoli | Three fixed panels Four sliding panels |
|---|---|



CB 600/4B
(281 cassetti - drawers)

- Pannello fisso con n. 5 CB50/4S + n. 4 CB50/3S x tre pannelli.
Fixed panel with n. 5 CB50/4S + n. 4 CB50/3S x three panels.
- Pannello scorrevole posteriore con n. 10 CB50/3S + n. 10 CB50/3S.
Sliding panel with n. 10 CB50/3S + n. 10 CB50/3S.
- Pannello scorrevole anteriore con n. 14 CB50/2S + n. 14 CB50/2S.
Sliding panel with n. 14 CB50/2S + n. 14 CB50/2S.

| | |
|---|---|
| Tre pannelli fissi Quattro pannelli scorrevoli | Three fixed panels Four sliding panels |
|---|---|

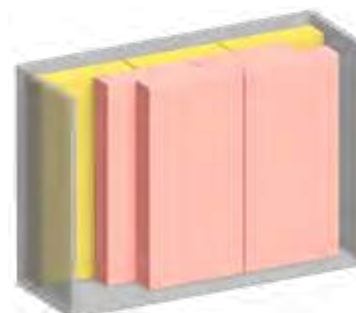

CB 600/4C
(370 cassetti - drawers)

- Pannello fisso con n. 10 CB50/3S + n. 10 CB50/3S + n. 10 CB50/3S.
Fixed panel with n. 10 CB50/3S + n. 10 CB50/3S + n. 10 CB50/3S.
- Pannello scorrevole posteriore con n. 14 CB50/2S + n. 14 CB50/2S.
Sliding panel with n. 14 CB50/2S + n. 14 CB50/2S.
- Pannello scorrevole anteriore con n. 14 CB50/2S + n. 14 CB50/2S.
Sliding panel with n. 14 CB50/2S + n. 14 CB50/2S.

| | |
|---|---|
| Tre pannelli fissi Quattro pannelli scorrevoli | Three fixed panels Four sliding panels |
|---|---|

| Art. | PANNELLI FISSI FIXED PANELS | PANN. SCORR. POST. REAR SLIDING PANELS | PANN. SCORR. ANT. SLIDING FRONT PANEL | TOT CASSETTI TOT. DRAWERS | L x P x H |
|-----------|--|---|--|------------------------------|---------------------|
| CB 600/4 | (5 CB50/4S + 4 CB50/3S) x 3 PANNELLI - PANELS | 10 CB50/3S + 10 CB50/3S | 10 CB50/3S + 10 CB50/3S | 201 | 1.870 x 600 x 1.950 |
| CB 600/4A | 10 CB50/3S + 10 CB50/3S +10 CB50/3S | 10 CB50/3S + 10 CB50/3S | 10 CB50/3S + 10 CB50/3S | 210 | 1.870 x 600 x 1.950 |
| CB 600/4B | (5 CB50/4S + 4 CB50/3S) x 3 PANNELLI - PANELS | 10 CB50/3S + 10 CB50/3S | 14 CB50/2S + 14 CB50/2S | 281 | 1.870 x 600 x 1.950 |
| CB 600/4C | 10 CB50/3S + 10 CB50/3S +10 CB50/3S | 14 CB50/2S + 14 CB50/2S | 14 CB50/2S + 14 CB50/2S | 370 | 1.870 x 600 x 1.950 |



Luce LED
per armadio
CB 400
LED light for
CB 400



Esempio
CB 400/4B



STRUTTURA ESTERNO CASSETTIERE
CASE



CASSETTI E VASCHE
DRAWERS AND CUPS



PRODOTTI IN
MATERIALE
RICICLABILE



FERRAMENTA & MAGAZZINO

Hardware & Storage



CRYSTAL BOX

armadi CB 600/6

Armadio a pannelli scorrevoli su cuscinetti a sfera.

Struttura con n. 3 pannelli fissi affiancati sul fondo + n. 6 scorrevoli, realizzata in lamiera elettrosaldada con barre di rinforzo. Verniciata a forno con polvere epossidica. Fornito smontato con manuale di assemblaggio e viteria.

Portata singolo pannello: kg 160 circa.

Ruote e perni silenziati in nylon.

Cabinet with sliding panels on balls bearing.

Frame equipped with n. 3 fixed panels placed side by side on the bottom + n. 6 sliding panels, made of electrowelded reinforced plate. Made of epoxy powder coated electro-welded sheet. Supplied disassembled with a handbook for assembly and screw and bolts. Load capacity of each panel: 160 kg about. Silent running nylon rollers and pins.

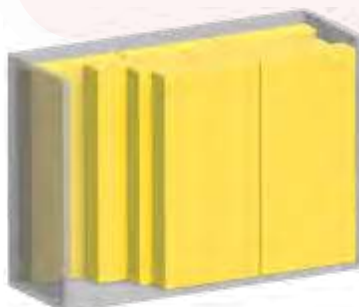

CB 600/6
(261 cassetti - drawers)

- Pannello fisso con n. 10 CB50/3S + n. 10 CB50/3S + n. 10 CB50/3S.
Fixed panel with n. 10 CB50/3S + n. 10 CB50/3S + n. 10 CB50/3S.
- Pannello scorrevole posteriore con n. 10 CB50/3S + n. 10 CB50/3S.
Sliding panel with n. 10 CB50/3S + n. 10 CB50/3S.
- Pannello scorrevole mediano con n. 10 CB50/3S + n. 10 CB50/3S.
Sliding panel with n. 10 CB50/3S + n. 10 CB50/3S.
- Pannello scorrevole anteriore con n. 10 CB50/3S + n. 10 CB50/3S.
Sliding panel with n. 10 CB50/3S + n. 10 CB50/3S.

Tre pannelli fissi
Sei pannelli scorrevoli

Three fixed panels
Six sliding panels



CB 600/6A
(341 cassetti - drawers)

- Pannello fisso con n. 5 CB50/4S + n. 4 CB50/3S x tre pannelli.
Fixed panel with n. 5 CB50/4S + n. 4 CB50/3S x three panels.
- Pannello scorrevole posteriore con n. 10 CB50/3S + n. 10 CB50/3S.
Sliding panel with n. 10 CB50/3S + n. 10 CB50/3S.
- Pannello scorrevole mediano con n. 10 CB50/3S + n. 10 CB50/3S.
Sliding panel with n. 10 CB50/3S + n. 10 CB50/3S.
- Pannello scorrevole anteriore con n. 14 CB50/2S + n. 14 CB50/2S.
Sliding panel with n. 14 CB50/2S + n. 14 CB50/2S.

Tre pannelli fissi
Sei pannelli scorrevoli

Three fixed panels
Six sliding panels



CB 600/6B
(421 cassetti - drawers)

- Pannello fisso con n. 5 CB50/4S + n. 4 CB50/3S x tre pannelli.
Fixed panel with n. 5 CB50/4S + n. 4 CB50/3S x three panels.
- Pannello scorrevole posteriore con n. 10 CB50/3S + n. 10 CB50/3S.
Sliding panel with n. 10 CB50/3S + n. 10 CB50/3S.
- Pannello scorrevole mediano con n. 14 CB50/2S + n. 14 CB50/2S.
Sliding panel with n. 14 CB50/2S + n. 14 CB50/2S.
- Pannello scorrevole anteriore con n. 14 CB50/2S + n. 14 CB50/2S.
Sliding panel with n. 14 CB50/2S + n. 14 CB50/2S.

Tre pannelli fissi
Sei pannelli scorrevoli

Three fixed panels
Six sliding panels

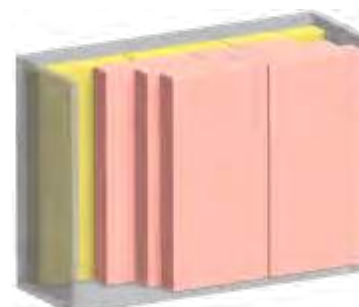

CB 600/6C
(510 cassetti - drawers)

- Pannello fisso con n. 10 CB50/3S + n. 10 CB50/3S + n. 10 CB50/3S.
Fixed panel with n. 10 CB50/3S + n. 10 CB50/3S + n. 10 CB50/3S.
- Pannello scorrevole posteriore con n. 14 CB50/2S + n. 14 CB50/2S.
Sliding panel with n. 14 CB50/2S + n. 14 CB50/2S.
- Pannello scorrevole mediano con n. 14 CB50/2S + n. 14 CB50/2S.
Sliding panel with n. 14 CB50/2S + n. 14 CB50/2S.
- Pannello scorrevole anteriore con n. 14 CB50/2S + n. 14 CB50/2S.
Sliding panel with n. 14 CB50/2S + n. 14 CB50/2S.

Tre pannelli fissi
Sei pannelli scorrevoli

Three fixed panels
Six sliding panels

| Art. | PANNELLI FISSI FIXED PANELS | PANN. SCORR. POST. REAR SLIDING PANELS | PANN. SCORR. MEDIANO REAR SLIDING PANELS | PANN. SCORR. ANT. SLIDING FRONT PANEL | TOT CASSETTI TOT. DRAWERS | L x P x H |
|-----------|--|---|---|--|------------------------------|---------------------|
| CB 600/6 | (10 CB50/3S) x 3 PANNELLI - PANELS | 10 CB50/3S + 10 CB50/3S | 10 CB50/3S + 10 CB50/3S | 10 CB50/3S + 10 CB50/3S | 261 | 1.870 x 800 x 1.950 |
| CB 600/6A | (5 CB50/4S + 4 CB50/3S) x 3 PANNELLI - PANELS | 10 CB50/3S + 10 CB50/3S | 10 CB50/3S + 10 CB50/3S | 14 CB50/2S + 14 CB50/2S | 341 | 1.870 x 800 x 1.950 |
| CB 600/6B | (5 CB50/4S + 4 CB50/3S) x 3 PANNELLI - PANELS | 10 CB50/3S + 10 CB50/3S | 14 CB50/2S + 14 CB50/2S | 14 CB50/2S + 14 CB50/2S | 421 | 1.870 x 800 x 1.950 |
| CB 600/6C | (10 CB50/3S) x 3 PANNELLI - PANELS | 14 CB50/2S + 14 CB50/2S | 14 CB50/2S + 14 CB50/2S | 14 CB50/2S + 14 CB50/2S | 510 | 1.870 x 800 x 1.950 |



Luce LED
per armadio
CB 400
LED light for
CB 400



Esempio
CB 400/6B



STRUTTURA ESTERNO CASSETTIERE
CASE



CASSETTI E VASCHE
DRAWERS AND CUPS



PRODOTTI IN
MATERIALE
RICICLABILE



CRYSTAL BOX carrello

Robusto e pratico carrello per esigenze di magazzinaggio mobile. Realizzato in lamiera elettrosaldata e verniciato a forno in polvere epossidica di colore grigio (simil Ral 7035). Dotato di n. 4 ruote gommare di cui 2 piroettanti (una con fermo). Forniti smontati e minuterie per l'assemblaggio.

Strong and practical wheeled trolley for storage.
Made of epoxy powder coated electro-welded sheet, in grey colour (similar to RAL 7035).
Complete with 4 rubber wheels: 2 fixed and 2 swivel castors (1 braked). Supplied disassembled with assembly screws and bolts.

FERRAMENTA & MAGAZZINO *Hardware & Storage*



Maniglia di trasporto.
Carrying handle.



Ruota con fermo.
Braked castor.



Esempio di allestimento e colori

| Art. | DESCRIZIONE DESCRIPTION | L x P x H |
|-------|--|---------------------------------|
| CB 30 | carrello in metallo CB 30. metal trolley CB 30. | 610 x 610 x 1.355 (utile 1.040) |

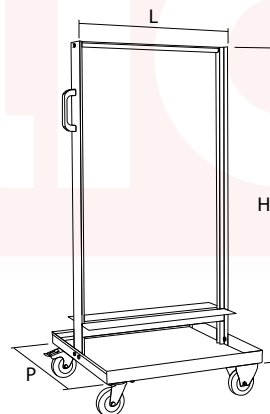

CB 30
(prodotto privo di cassettiere)
(item supplied without drawers)

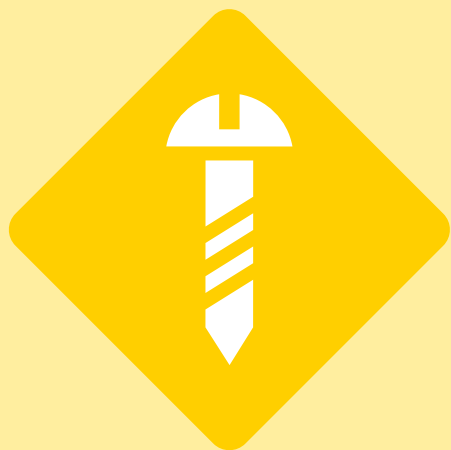

FERRAMENTA & MAGAZZINO

Hardware & Storage



C-MINI

cassettiere componibili MINI

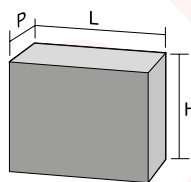

| art | L | H | P | Imballo pezzi Pack quantity | Cassetti Drawers |
|------|-----|-----|-----|--------------------------------|---|
| A | 225 | 169 | 133 | 6 | 24 cassetti: l. 48 - p. 114,5 - h. 24 |
| T/A | 225 | 169 | 133 | 6 | 24 cassetti: l. 48 - p. 114,5 - h. 24 |
| A1 | 225 | 169 | 133 | 6 | 12 cassetti: l. 48 - p. 114,5 - h. 50 |
| T/A1 | 225 | 169 | 133 | 6 | 12 cassetti: l. 48 - p. 114,5 - h. 50 |
| B | 225 | 169 | 133 | 6 | 12 cassetti: l. 103 - p. 114,5 - h. 24 |
| T/B | 225 | 169 | 133 | 6 | 12 cassetti: l. 103 - p. 114,5 - h. 24 |
| C | 225 | 169 | 133 | 6 | 6 cassetti: l. 103 - p. 114,5 - h. 50 |
| T/C | 225 | 169 | 133 | 6 | 6 cassetti: l. 103 - p. 114,5 - h. 50 |
| D | 225 | 169 | 133 | 6 | 3 cassetti: l. 214 - p. 114,5 - h. 50 |
| T/D | 225 | 169 | 133 | 6 | 3 cassetti: l. 214 - p. 114,5 - h. 50 |
| M | 225 | 169 | 133 | 6 | 4 cassetti: l. 48 - p. 114,5 - h. 24 2 cassetti: l. 48 - p. 114,5 - h. 50 2 cassetti: l. 103 - p. 114,5 - h. 24 1 cassetto: l. 103 - p. 114,5 - h. 50 1 cassetto: l. 214 - p. 114,5 - h. 50 |
| T/M | 225 | 169 | 133 | 6 | 4 cassetti: l. 48 - p. 114,5 - h. 24 2 cassetti: l. 48 - p. 114,5 - h. 50 2 cassetti: l. 103 - p. 114,5 - h. 24 1 cassetto: l. 103 - p. 114,5 - h. 50 1 cassetto: l. 214 - p. 114,5 - h. 50 |

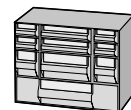
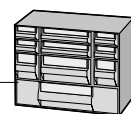

VASCHE

| art | L | H | P |
|-----|-----|----|----|
| A | 47 | 22 | 37 |
| B | 37 | 22 | 27 |
| C | 56 | 46 | 51 |
| A1 | 56 | 46 | 47 |
| D | 110 | 46 | 56 |



BIANCO (BI)

CARTELLINI IN DOTAZIONE STANDARD
TAGS INCLUDED

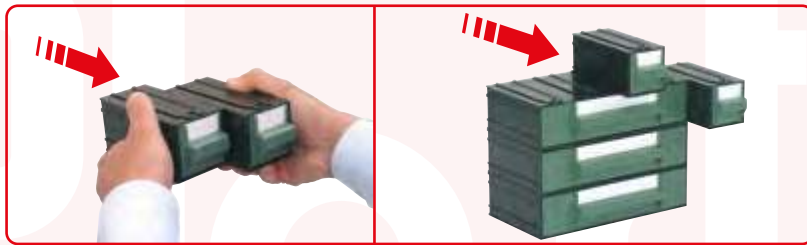

A



A1



B



C



D



M



T/A



T/A1



T/B



T/C



T/D



T/M



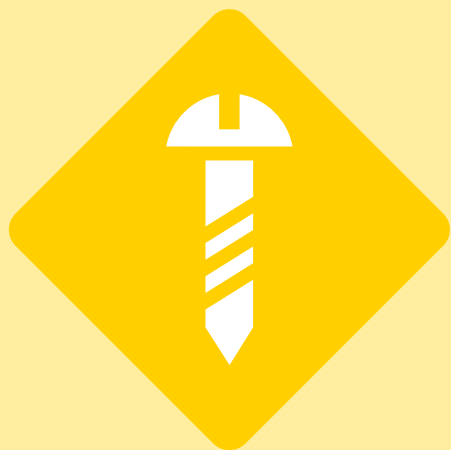

C-MIDI

cassettiere componibili MIDI

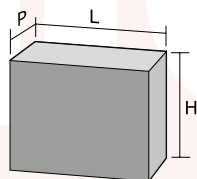

**FERRAMENTA &
MAGAZZINO**
Hardware & Storage



| art | L | H | P | Imballo pezzi Pack quantity | Cassetti Drawers |
|------|-----|-----|-----|--------------------------------|--|
| T/42 | 225 | 225 | 225 | 8 | 2 cassetti: l. 212 - p. 198 - h. 103 |
| T/43 | 225 | 225 | 225 | 8 | 4 cassetti: l. 212 - p. 198 - h. 48 |
| T/44 | 225 | 225 | 225 | 8 | 4 cassetti: l. 101- p. 198 - h. 103 |
| T/45 | 225 | 225 | 225 | 8 | 4 cassetti: l. 101- p. 198 - h. 103 con 8 separatori estraibili |

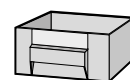

CARTELLINI IN DOTAZIONE STANDARD
TAGS INCLUDED





T/42



T/43



T/44



T/45





FERRAMENTA & MAGAZZINO









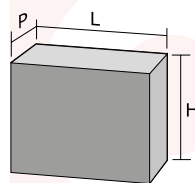

Hardware & Storage



C-MAXI

cassettiere componibili MAXI



| art | L | H | P | Imballo pezzi Pack quantity | Cassetti Drawers | |
|-------|-----|-----|-----|--------------------------------|---|---|
| * L | 225 | 228 | 263 | 8 | 6 cassetti: l. 101 - p. 241 - h. 67 con 12 separatori estraibili trasparenti |  |
| * T/L | 225 | 228 | 263 | 8 | 6 cassetti: l. 101 - p. 241 - h. 67 con 12 separatori estraibili trasparenti |  |
| * E | 340 | 340 | 270 | 1 | 6 cassetti: l. 155 - p. 241 - h. 100 |  |
| T/E | 340 | 340 | 270 | 1 | 6 cassetti: l. 155 - p. 241 - h. 100 |  |
| * F | 562 | 228 | 390 | 1 | 4 cassetti: l. 266 - p. 357 - h. 100 |  |
| T/F | 562 | 228 | 390 | 1 | 4 cassetti: l. 266 - p. 357 - h. 100 |  |
| H/3 | 562 | 228 | 390 | 1 | 6 cassetti: l. 266 - p. 358 - h. 65 |  |
| T/3 | 562 | 228 | 390 | 1 | 6 cassetti: l. 266 - p. 358 - h. 65 |  |
| * G | 393 | 228 | 390 | 1 | 2 cassetti: l. 376 - p. 357 - h. 100 |  |
| * F/T | 562 | 228 | 390 | 1 | 4 cassetti: l. 266 - p. 357 - h. 100 |  |

* CARTELLINI E COPRI CARTELLINI IN DOTAZIONE STANDARD
* TAGS E TAGS COVER INCLUDED

Cassettiere MAXI

maggiore resistenza al carico,
corpo esterno per ogni cassetto.

Modules MAXI

High load resistance and bodies drawers.

ESPOSITORE
per F - G





H/3



L



E



F



F/T

Cassetti con separatore longitudinale fisso.
Drawers with longitudinal fixed divisor.



G



T/L

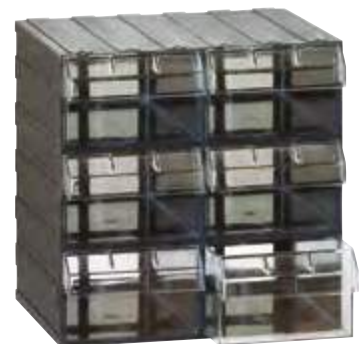

T/E



T/F



T/3





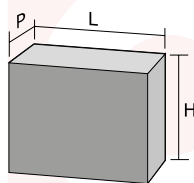

C-MAXI

cassettiere componibili MAXI



**FERRAMENTA &
MAGAZZINO**
Hardware & Storage

| art | L | H | P | Imballo pezzi Pack quantity | Cassetti Drawers |
|-----------|-----|-----|-----|--------------------------------|--|
| MOBIL 1 | 225 | 450 | 323 | 1 | 4 cassetti: l. 210 - p. 289 - h. 103  |
| MOBIL 101 | 225 | 450 | 323 | 1 | 4 cassetti: l. 210 - p. 289 - h. 103  |
| MOBIL 2 | 169 | 228 | 323 | 8 | 2 cassetti: l. 155 - p. 289 - h. 103  |
| MOBIL 102 | 169 | 228 | 323 | 8 | 2 cassetti: l. 155 - p. 289 - h. 103  |
| MOBIL 3 | 562 | 228 | 390 | 1 | 4 cassetti: l. 266 - p. 360 - h. 103 |
| MOBIL 103 | 562 | 228 | 390 | 1 | 4 cassetti: l. 266 - p. 360 - h. 103 |

CARTELLINI IN DOTAZIONE STANDARD
TAGS INCLUDED





MOBIL 1



MOBIL 2



MOBIL 1/T



Composizione da 4 cassette con separatore Longitudinale fisso e 4 separatori estraibili
Fixed divider and 4 movable dividers



MOBIL 3



MOBIL 101



MOBIL 102



MOBIL 103

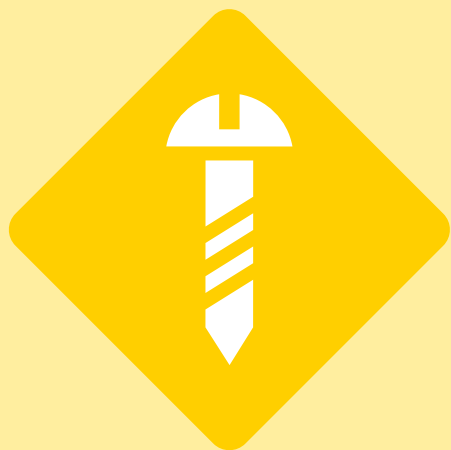

FERRAMENTA & MAGAZZINO

Hardware & Storage

C-MAXI cassettiere componibili MAXI

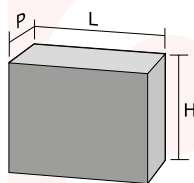

| art | L | H | P | Imballo pezzi Pack quantity | Cassetti Drawers |
|-------|-----|-----|-----|--------------------------------|--------------------------------------|
| S40 | 238 | 262 | 423 | 1 | 2 cassetti: l. 220 - p. 390 - h. 120 |
| T40 | 238 | 262 | 423 | 1 | 2 cassetti: l. 220 - p. 390 - h. 120 |
| S40/T | 238 | 262 | 423 | 1 | 2 cassetti: l. 220 - p. 390 - h. 120 |

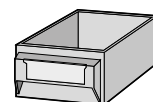

CARTELLINI IN DOTAZIONE STANDARD
TAGS INCLUDED

S40 - T40 - S40/T

cassettiere non componibili con le altre serie, realizzate per utilizzo su scaffali 1000 mm x 400 mm

S40 - T40 - S40T

modules media structure not compatible with other series, designed for use on shelves 1000 mm x 400 mm

BASI per C-MAXI

| art | L | H | P | Imballo pezzi Pack quantity |
|--------|-----|----|-----|--------------------------------|
| BASE E | 165 | 70 | 250 | 1 |
| BASE F | 280 | 70 | 370 | 1 |
| BASE G | 390 | 70 | 370 | 1 |

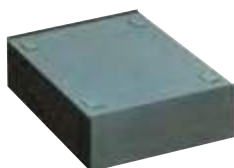

BASE E

Base E per composizioni E - T/ E
Base E for modules E - T/ E



BASE F

Base F per composizioni F - F/ T - T/ F
H/ 3 - T/ 3 - MOBIL 3 - MOBIL 103
Base F for modules F - F/ T - T/ F
H/ 3 - T/ 3 - MOBIL 3 - MOBIL 103



BASE G

Base G per composizione G
Base G for module G





S40



T40



con 3 separatori
estraibili
with 3 removable
dividers

S40/T

4 cassetti affiancati consentono di utilizzare senza perdite di spazio la luce frontale nominale di 1.000 mm. e la profondità di 400 mm.

4 drawers, one close to the other, allow to exploit a linear space of 1.000 mm. and a width of 400 mm.



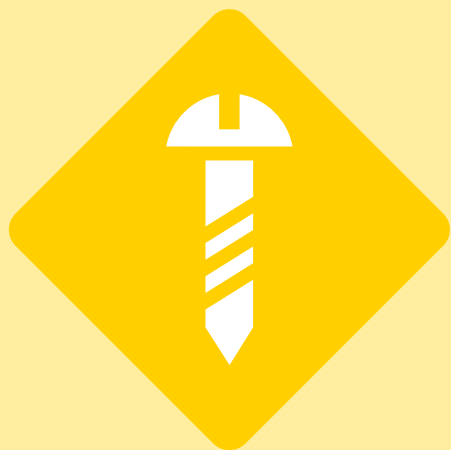

C-MAXI vaschette

ESEMPI DI ALLESTIMENTO:

**FERRAMENTA &
MAGAZZINO**
Hardware & Storage



F1 - F2 - F3 per cassettiere: F - T/ F - F/ T - MOBIL 3 - MOBIL 103

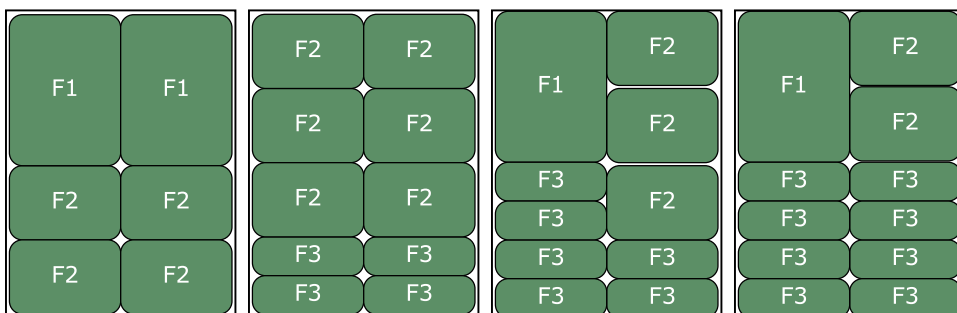
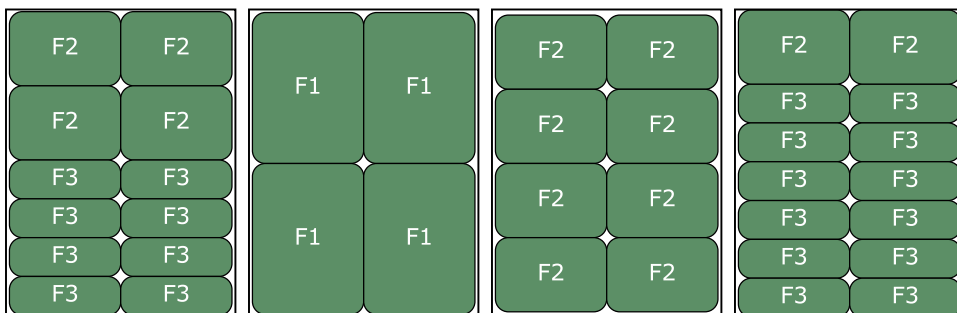

H1 - H2 - H3 per cassettiere: H/ 3 - T/ 3

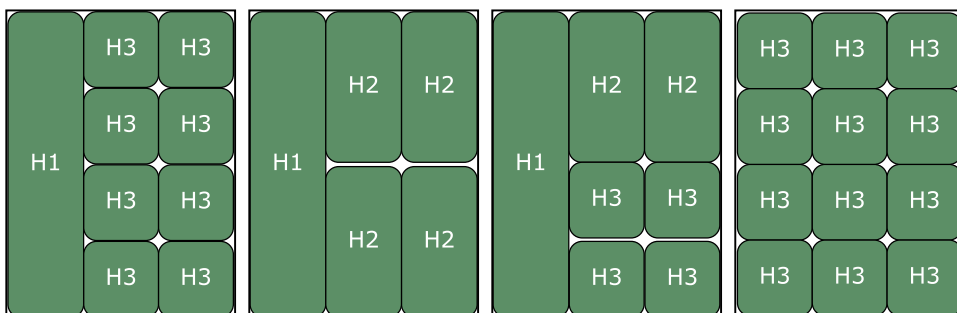

E per cassettiere: E- T/E

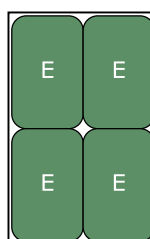

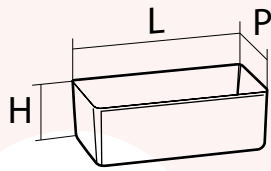

| art | L | H | P |
|-----|-----|----|-----|
| E | 117 | 91 | 74 |
| F1 | 175 | 91 | 129 |
| F2 | 129 | 91 | 86 |
| F3 | 129 | 91 | 45 |

| art | L | H | P |
|-----|-----|----|-----|
| G1 | 175 | 91 | 108 |
| H1 | 355 | 55 | 88 |
| H2 | 175 | 55 | 88 |
| H3 | 87 | 55 | 88 |



F1



F2



F3



H1



H2



H3



E



G1



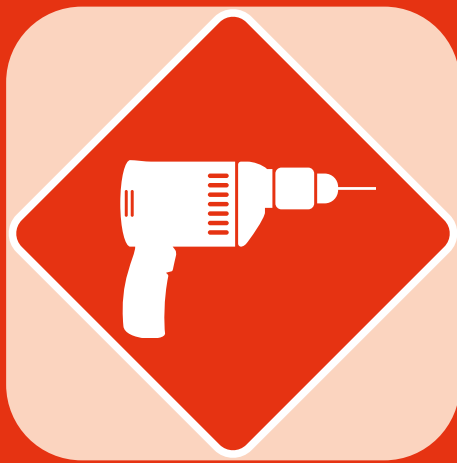

52



MOPLA

56



CLASS

62



EASY BOX

64



ESPACE

BRICOLAGE & FAI DA TE

Do it yourself



**SCAFFALI
REGOLABILI**



SCAFFALI FISSI

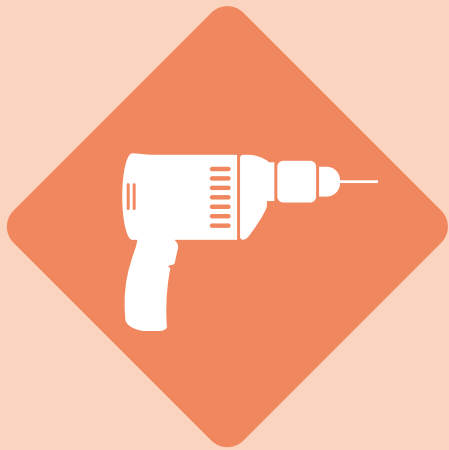

MOPLA composizioni

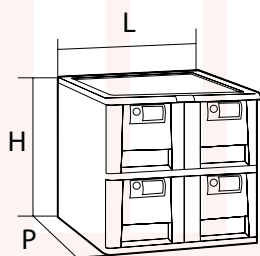

BRICOLAGE & FAI DA TE

Do it yourself



| art | L | H | P | Imballo Pz. Pack Qty. | Cassetti Drawers |
|------------------|-----|-----|-----|--------------------------|--------------------------------------|
| MOPLA 102 | 450 | 420 | 460 | 1 | 2 cassetti: l. 405 - p. 405 - h. 163 |
| MOPLA 104 | 450 | 420 | 460 | 1 | 4 cassetti: l. 180 - p. 405 - h. 163 |
| MOPLA 104 BIS | 450 | 420 | 460 | 1 | 4 cassetti: l. 405 - p. 405 - h. 63 |

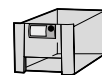
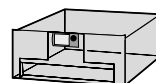

ROTELLA
CASSETTO GUIDA



BARILETTO DI
SCORRIMENTO



CHIUSURA CON
CHIAVE



PIEDINO
ANTISDRUCCIOLO



ELEMENTO DI CONNESSIONE
ORIZZONTALE E VERTICALE



PORTA CARTELLINO
INTERCAMBIABILE



MOPLA 102



MOPLA 104



MOPLA 104 BIS

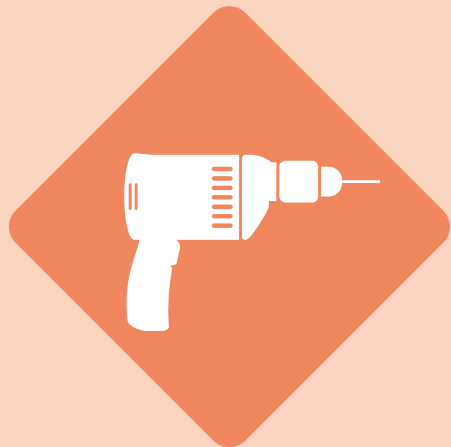

MOPLA cassettiere con ruote

| art | L | H | P | Imballo pezzi Pack quantity | Cassetti Drawers |
|-------------|-----|-----|-----|--------------------------------|--------------------------------------|
| MOPLA 203 R | 450 | 695 | 460 | 1 | 3 cassetti: l. 405 - p. 405 - h. 163 |
| MOPLA 206 R | 450 | 695 | 460 | 1 | 6 cassetti: l. 405 - p. 405 - h. 63 |

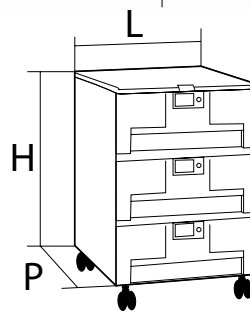

BRICOLAGE & FAI DA TE

Do it yourself



Esempi allestimenti cassetti

La vaschetta M10 e le due vaschette M9 hanno posizione fissa e non modificabile (vedi illustrazione sotto).

I vani laterali A e B possono essere allestiti su misura con le vaschette M5 - M6 - M7 - M8.

Cup M10 and both cups M9 are fixed and cannot be removed (see picture below).

The side compartments A and B can be equipped with cups M5 - M6 - M7 - M8.

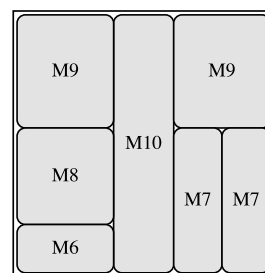
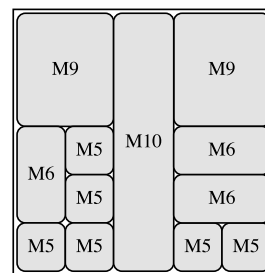

M9
L. 152 - P. 180 - H.57

M10
L. 405 - P. 92,5 - H. 57

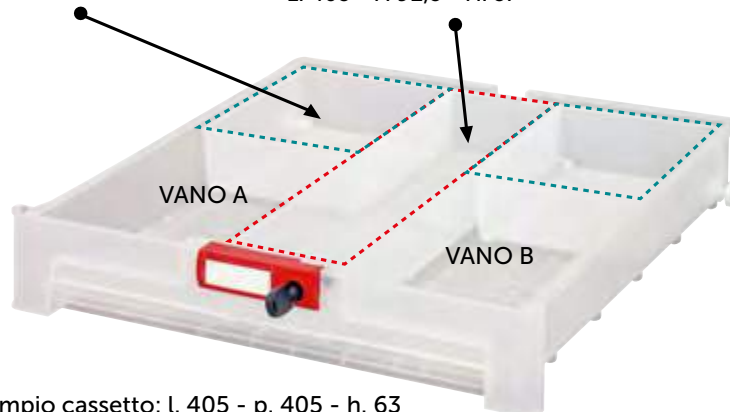

Esempio cassetto: l. 405 - p. 405 - h. 63



MOPLA 203 R



MOPLA 206 R

Vaschette x MOPLA 206 R e 104 Bis

○
TRASPARENTE (TR)



M5

L. 75,5 - P. 75,5 - H.57



M6

L. 151 - P. 75,5 - H.57



M7

L. 228 - P. 75,5 - H.57



M8

L. 151 - P. 151 - H.57



M9

L. 152 - P. 180 - H.57



M10

L. 405 - P. 92,5 - H. 57



CLASS organizer

| art | L | H | P | H utile | Imballo pezzi Pack quantity |
|-----------|-----|----|-----|---------|--------------------------------|
| CLASS 9 | 130 | 26 | 86 | 20,5 | 48 |
| CLASS 9VA | 130 | 26 | 86 | 19 | 48 |
| CLASS 10 | 180 | 40 | 125 | 35,5 | 36 |
| CLASS 11 | 268 | 50 | 125 | 45 | 24 |
| CLASS 12 | 268 | 50 | 125 | 42,5 | 24 |
| CLASS 13 | 268 | 50 | 188 | 45 | 18 |
| CLASS 14 | 268 | 50 | 188 | 43 | 18 |

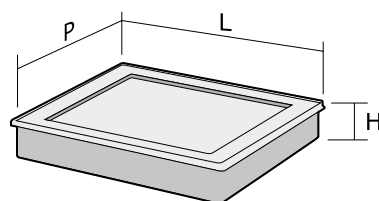

BRICOLAGE & FAI DA TE

Do it yourself





CLASS 9



CLASS 9VA
con 6 vaschette estraibili

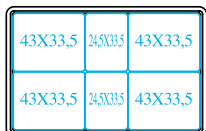

CLASS 10

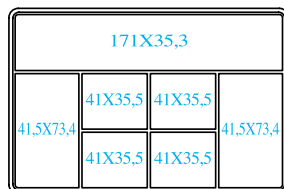

CLASS 11

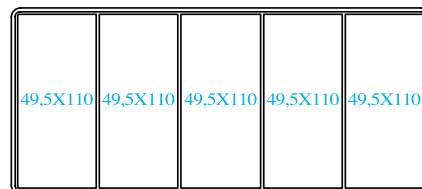

CLASS 12
con 10 vaschette estraibili



CLASS 13

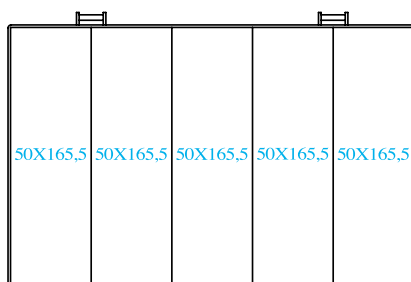

CLASS 14
con 15 vaschette estraibili

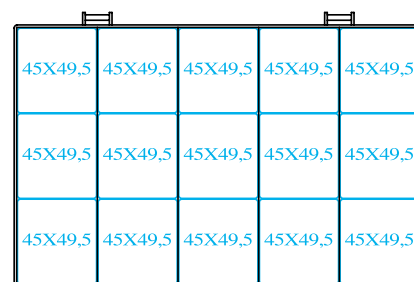

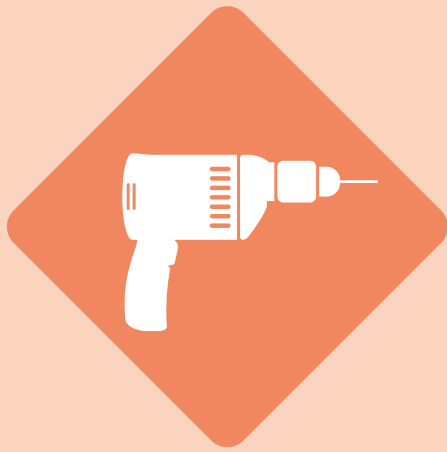

CLASS organizer

| art | L | H | P | H utile | Imballo pezzi Pack quantity |
|----------|-----|----|-----|------------|--------------------------------|
| CLASS 18 | 190 | 40 | 155 | 30 | 16 |
| CLASS 19 | 190 | 40 | 155 | 27,5 | 16 |
| CLASS 20 | 240 | 55 | 186 | 45 | 12 |
| CLASS 22 | 240 | 55 | 186 | 42 | 12 |

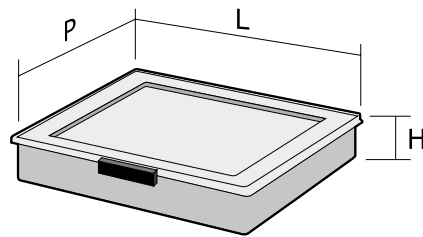

BRICOLAGE & FAI DA TE

Do it yourself



**CHIUSURA DI SICUREZZA
SECURITY CLOSURE**



CLASS 18

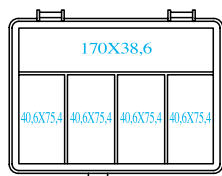

CLASS 19
Con 12 vaschette estraibili

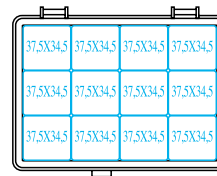

CLASS 20

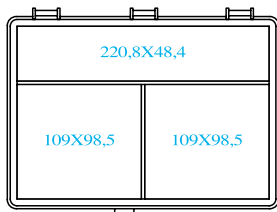

CLASS 22
con 8 vaschette estraibili

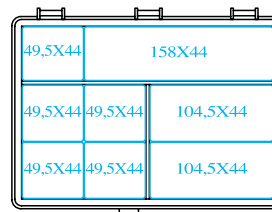

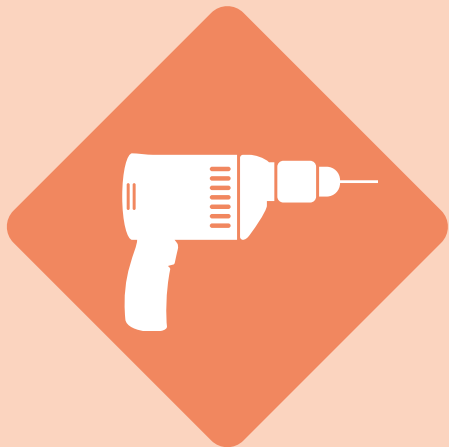

CLASS organizer

| art | L | H | P | H utile | Imballo pezzi Pack quantity |
|----------|-----|----|-----|---------|--------------------------------|
| CLASS 30 | 325 | 55 | 260 | 45 | 6 |
| CLASS 31 | 325 | 55 | 260 | 45 | 6 |
| CLASS 32 | 325 | 55 | 260 | 42 | 6 |
| CLASS 41 | 400 | 70 | 340 | 56 | 5 |
| CLASS 42 | 400 | 70 | 340 | 53 | 5 |

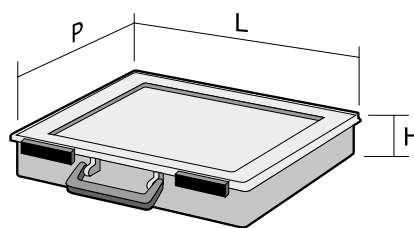

BRICOLAGE & FAI DA TE

Do it yourself



VASCHETTE CLASS



CLASS 1
L. 55 - P. 50 - H. 45



CLASS 2
L. 110 - P. 50 - H. 45



CLASS 3
L. 165 - P. 50 - H. 45



CLASS 4
L. 40 - P. 43 - H. 30



CLASS 5
L. 76 - P. 76 - H. 57



CLASS 6
L. 152 - P. 76 - H. 57



CLASS 7
L. 228 - P. 76 - H. 57



CLASS 8
L. 152 - P. 152 - H. 57

○
TRASPARENTE (TR)



CLASS 30

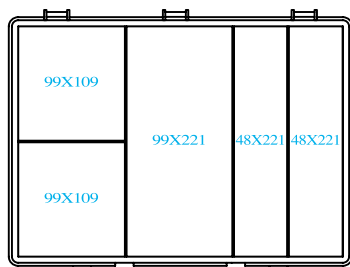

CLASS 31

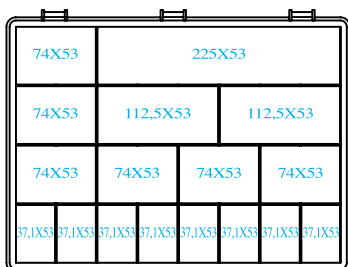

CLASS 32
con 16 vaschette estraibili

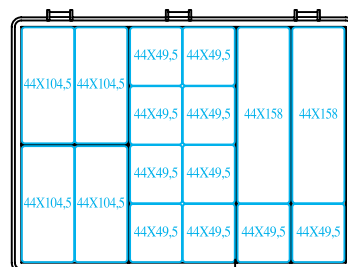

CLASS 41
con 12 divisori estraibili

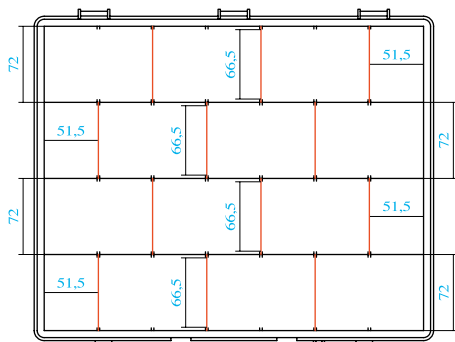

CLASS 42
con 10 vaschette estraibili

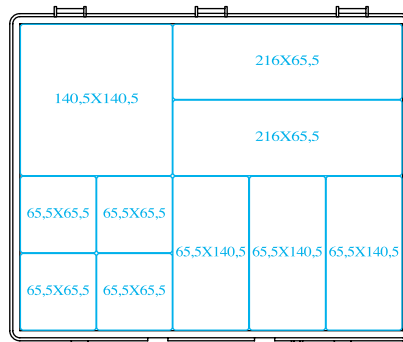



EASY BOX

portautensili

| art | L | H | P | Imballo Pezzi Packing Pieces |
|---------------|-----|-----|-----|---------------------------------|
| EASY BOX 12 | 343 | 165 | 229 | 10 |
| EASY BOX 12/A | 343 | 205 | 229 | 8 |
| EASY BOX 16 | 383 | 245 | 263 | 6 |
| EASY BOX 20 | 483 | 267 | 272 | 6 |
| EASY BOX 24 | 565 | 286 | 286 | 3 |

BRICOLAGE & FAI DA TE

Do it yourself

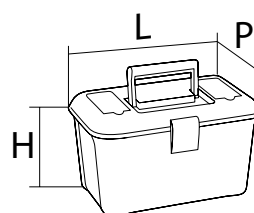

il Plastic®



EASY BOX 12



EASY BOX 12/A



EASY BOX 16



EASY BOX 20



EASY BOX 24



PRODOTTI IN
MATERIALE
RICICLABILE

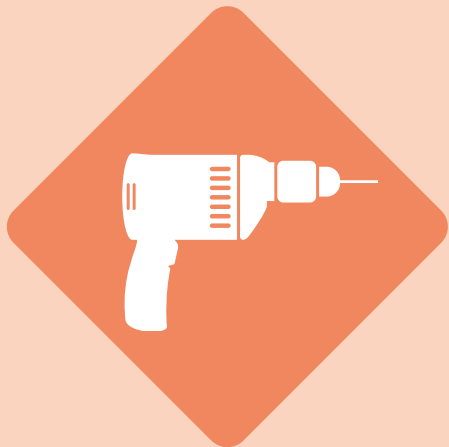

ESPACE cassettiere

| art | L | H | P | Imballo pezzi Pack quantity | Cassetti Drawers |
|-----------|-----|-----|-----|--------------------------------|-------------------------------------|
| ESPACE 12 | 220 | 180 | 150 | 12 | 12 cassetti: l. 60 - p. 137 - h. 37 |
| ESPACE 20 | 290 | 225 | 150 | 10 | 20 cassetti: l. 60 - p. 137 - h. 37 |
| ESPACE 30 | 365 | 270 | 150 | 4 | 30 cassetti: l. 60 - p. 137 - h. 37 |

BRICOLAGE & FAI DA TE

Do it yourself

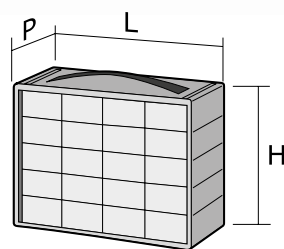



ESPACE 12

12 cassette con 12 divisori estraibili



ESPACE 20

20 cassette con 20 divisori estraibili



ESPACE 30

30 cassette con 30 divisori estraibili

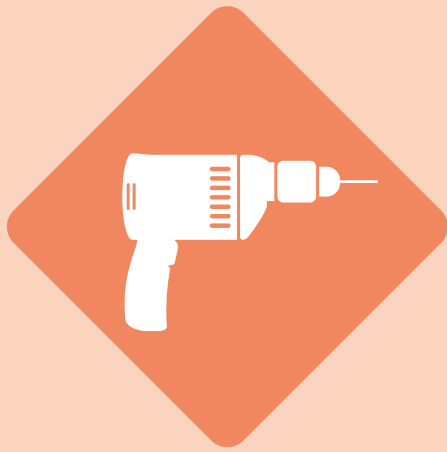

SCAFFALI

scaffali regolabili

| art | L | H | P | Imballo pezzi Pack quantity |
|----------|-----|-------|-----|--------------------------------|
| TIDY 705 | 725 | 1.880 | 350 | 1 |
| TIDY 805 | 825 | 1.880 | 400 | 1 |
| TIDY 905 | 925 | 1.880 | 450 | 1 |

BRICOLAGE & FAI DA TE

Do it yourself

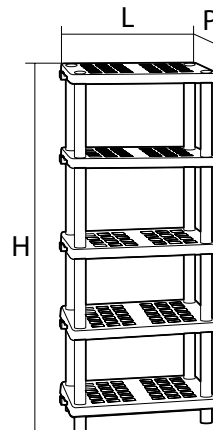

Scaffale modulare a 5 ripiani regolabili in altezza anche a scaffale montato
5 Adjustable shelf unit height also when assembled



Plastic®



TIDY 705



TIDY 805



TIDY 905

5/10 MIN.
ASSEMBLING



WATER RESISTANT

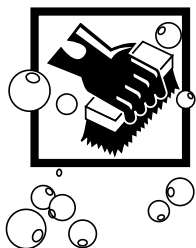

HIGH RESISTANCE
LOADED

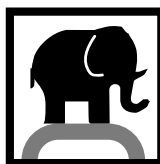

TOOLS
NOT REQUIRED



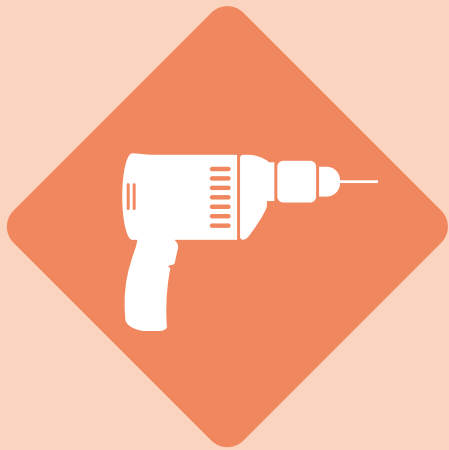

SCAFFALI

scaffali fissi

| art | L | H | P | Imballo pezzi Pack quantity |
|----------|-----|-------|-----|--------------------------------|
| TIDY 814 | 810 | 1.360 | 392 | 1 |
| TIDY 414 | 392 | 1.360 | 392 | 1 |
| TIDY 212 | 392 | 520 | 392 | 1 |

BRICOLAGE & FAI DA TE

Do it yourself

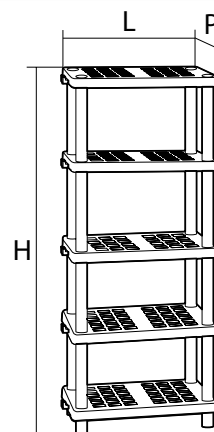

Scaffale modulare a 2 e 4 ripiani
2 and 4 shelf unit



ilPlastic®



TIDY 212



TIDY 414



TIDY 814

5/10 MIN.
ASSEMBLING



WATER RESISTANT

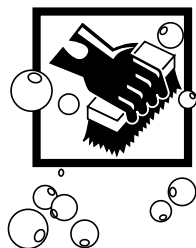

HIGH RESISTANCE
LOADED

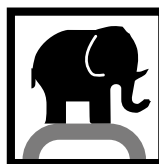

TOOLS
NOT REQUIRED





72

**BIDONI
CARRELLATI 120 l**



74

**BIDONI
CARRELLATI 240 l**



77

**BIDONI
CARRELLATI 360 l**



78

**CASSONETTI
4 RUOTE 660 l**



80

**CASSONETTI
4 RUOTE 770 l**



82

**CASSONETTI
4 RUOTE 1100 l**



84

BIDONE 80



85

BIDONE 100



86

**BIDONE
100 PUSH**

PULIZIA & RACCOLTA DIFFERENZIATA

Cleaning & Waste collection



87

NELLO



88

TRESPOLO



90

ECO-AIR



91

BIDONE 91



92

**BIDONI INDUSTRIALI
da 35 a 200 l**



93

**BIDONI INDUSTRIALI
da 35 a 300 l**



94

PULIZIA



95

DUSTY



96

**ECOLOGY 25/35
da 25 a 35 l**



BIDONI CARRELLATI 120 l

Bidone carrellato 120 litri a due ruote per la raccolta differenziata. Prodotto realizzato in HDPE (polietilene alta densità) 100% riciclabile, stabilizzato UV per utilizzo in ambienti esterni. Capacità di carico max 60 kg. Predisposto per presa frontale a pettine a norma DIN. Dotato di due ruote in gomma diametro 200 mm. Grande maneggevolezza, maniglie ergonomiche, bordi e spigoli arrotondati. Coperchio con apertura a libro e bordo anti infiltrazione, sede per alloggiamento microchip, elevata resistenza meccanica ed agli agenti chimici, facile da pulire e sanificare. Disponibile in 8 colori.

Two-wheeled 120 liter mobile waste bin for differential refuse collection. Product made of 100% recyclable HDPE (high density polyethylene), UV stabilized for outdoor use. Max load capacity 60 kg. Prepared for DIN standard frontal socket. Equipped with two 200 mm diameter rubber wheels. Easy handling, ergonomic handles, rounded corners and edges. Lid with book opening and anti-infiltration edge, seat for microchip housing, high mechanical and chemical resistance, easy to clean and sanitize. Available in 8 colors.



PRODOTTI IN
MATERIALE
RICICLABILE

PULIZIA & RACCOLTA DIFFERENZIATA

*Cleaning & waste
collection*

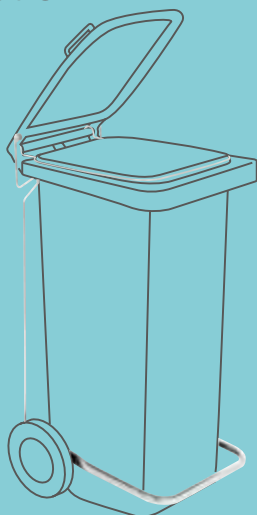

1204

Kit pedale + anello per bidone 120 l
120 l bin pedal and ring

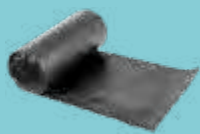

95/120

Sacchetti immondizia per bidone
raccolta differenziata 120 l
120 l bin liners bags



1/120

Anello fermasacco per
bidone 120 l

120 l bin liners bags

| Carrellato | 120 litri |
|---------------|-----------|
| A | 930 mm |
| B | 875 mm |
| C | 485 mm |
| D | 550 mm |
| E | 480 mm |
| F | 355 mm |
| G | 480 mm |
| PESO / WEIGHT | 9 Kg |

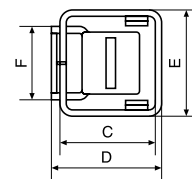
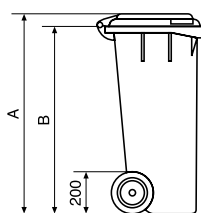

1/120/5
120 litri



UNI EN 840
Certificato
Certified



BIANCO LATTE
(BIL)

GIALLO
(GIA)

VERDE SCURO
(VES)

VERDE BIDONE
(VEB)

BRUNO BIDONE
(BRB)

BLU BIDONE
(BLB)

ROSSO BIDONE
(ROB)

GRIGIO BIDONE
(GRB)

BIDONI CARRELLATI BICOLORE 120 l

Bidone carrellato 120 litri bicolore a due ruote per la raccolta differenziata.
Prodotto realizzato in HDPE (polietilene alta densità) 100% riciclabile, stabilizzato UV per utilizzo in ambienti esterni.
Capacità di carico max 60 kg. Predisposto per presa frontale a pettine a norma DIN.
Dotato di due ruote in gomma diametro 200 mm.
Grande maneggevolezza, maniglie ergonomiche, bordi e spigoli arrotondati.
Coperchio con apertura a libro e bordo anti infiltrazione, sede per alloggiamento microchip, elevata resistenza meccanica ed agli agenti chimici, facile da pulire e sanificare. Bidone grigio e coperchi in 4 colori differenti.

*Two-wheeled bicolor 120 liter mobile waste bin for differential refuse collection
Product made of 100% recyclable HDPE (high density polyethylene), UV stabilized for outdoor use. Max load capacity 60 kg.
Prepared for DIN standard frontal socket.
Equipped with two 200 mm diameter rubber wheels. Easy handling, ergonomic handles, rounded corners and edges. Lid with book opening and anti-infiltration edge, seat for microchip housing, high mechanical and chemical resistance, easy to clean and sanitize.
Available with grey body and lid in 4 different colors.*



1/120/5
120 litri

| Carrellato | 120 litri |
|---------------|-----------|
| A | 930 mm |
| B | 875 mm |
| C | 485 mm |
| D | 550 mm |
| E | 480 mm |
| F | 355 mm |
| G | 480 mm |
| PESO / WEIGHT | 9 Kg |

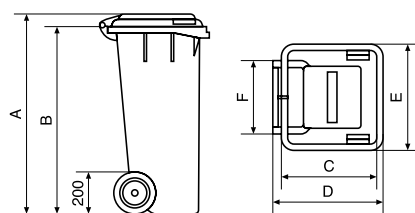

PRODOTTI IN
MATERIALE
RICICLABILE



1/ 120

Anello fermasacco per
bidone bicolore 120 l
120 l bin liners bags



95/ 120

Sacchetti immondizia per bidone
raccolta differenziata 120 l
120 l bin liners bags

Adesivi in dotazione (non applicati)
Stickers supplied (not applied)

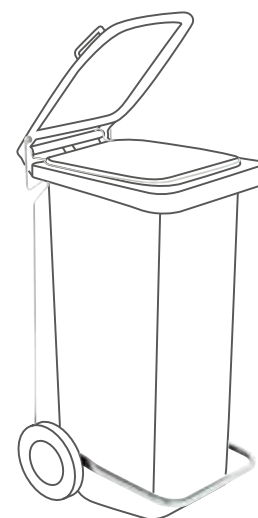

1204

Kit pedale + anello per
bidone 120 l
120 l bin pedal and ring



GRIGIO-GIALLO
(GRB-GIA)



GRIGIO-VERDE
(GRB-VES)



GRIGIO-BLU
(GRB-BLB)



GRIGIO-ROSSO
(GRB-ROB)



BIDONI CARRELLATI 240 l

Bidone carrellato 240 litri a due ruote per la raccolta differenziata. Prodotto realizzato in HDPE (polietilene alta densità) 100% riciclabile, stabilizzato UV per utilizzo in ambienti esterni. Capacità di carico max 116 kg. Predisposto per presa frontale a pettine a norma DIN. Dotato di due ruote in gomma diametro 200 mm. Grande maneggevolezza, maniglie ergonomiche, bordi e spigoli arrotondati. Coperchio con apertura a libro e bordo anti infiltrazione, sede per alloggiamento microchip, elevata resistenza meccanica ed agli agenti chimici, facile da pulire e sanificare. Disponibile in 8 colori.



PRODOTTI IN
MATERIALE
RICICLABILE



Two-wheeled 240 liter mobile waste bin for differential refuse collection. Product made of 100% recyclable HDPE (high density polyethylene), UV stabilized for outdoor use. Max load capacity 116 kg. Prepared for DIN standard frontal socket. Equipped with two 200 mm diameter rubber wheels. Easy handling, ergonomic handles, rounded corners and edges. Lid with book opening and anti-infiltration edge, seat for microchip housing, high mechanical and chemical resistance, easy to clean and sanitize. Available in 8 colors.

PULIZIA & RACCOLTA DIFFERENZIATA

Cleaning & waste collection

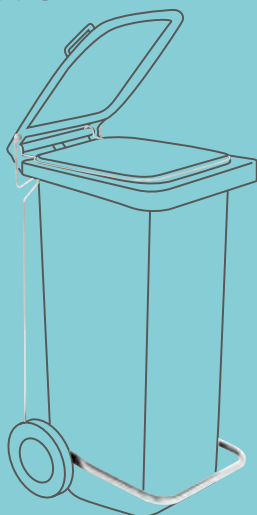

2404

Kit pedale + anello per bidone 240 l
240 l bin pedal and ring

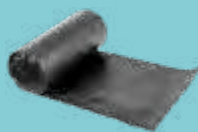

95/ 240

Sacchetti immondizia per bidone raccolta differenziata 240 l
240 l bin liners bags



1/ 240

Anello fermasacco per bidone 240 l

240 l bin liners bags

| | |
|---------------|-----------|
| Carrellato | 240 litri |
| A | 1070 mm |
| B | 995 mm |
| C | 655 mm |
| D | 730 mm |
| E | 580 mm |
| F | 420 mm |
| G | 570 mm |
| PESO / WEIGHT | 13 Kg |

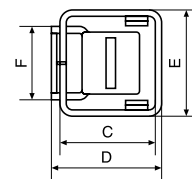
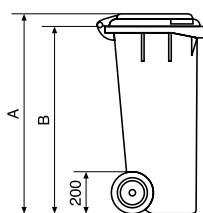

1/120/5
120 litri



UNI EN 840
Certificato
Certified



BIANCO LATTE (BIL)

GIALLO (GIA)

VERDE SCURO (VES)

VERDE BIDONE (VEB)

BRUNO BIDONE (BRB)

BLU BIDONE (BLB)

ROSSO BIDONE (ROB)

GRIGIO BIDONE (GRB)

BIDONI CARRELLATI BICOLORE 240 l

Bidone carrellato 240 litri bicolore a due ruote per la raccolta differenziata. Prodotto realizzato in HDPE (polietilene alta densità) 100% riciclabile, stabilizzato UV per utilizzo in ambienti esterni. Capacità di carico max 116 kg. Predisposto per presa frontale a pettine a norma DIN. Dotato di due ruote in gomma diametro 200 mm. Grande maneggevolezza, maniglie ergonomiche, bordi e spigoli arrotondati. Coperchio con apertura a libro e bordo anti infiltrazione, sede per alloggiamento microchip, elevata resistenza meccanica ed agli agenti chimici, facile da pulire e sanificare. Bidone grigio e coperchi in 4 colori differenti.

Two-wheeled bicolor 240 liter mobile waste bin for differential refuse collection. Product made of 100% recyclable HDPE (high density polyethylene), UV stabilized for outdoor use. Max load capacity 116 kg. Prepared for DIN standard frontal socket. Equipped with two 200 mm diameter rubber wheels. Easy handling, ergonomic handles, rounded corners and edges. Lid with book opening and anti-infiltration edge, seat for microchip housing, high mechanical and chemical resistance, easy to clean and sanitize. Available with grey body and lid in 4 different colors.

| Carrellato | 240 litri |
|---------------|-----------|
| A | 1070 mm |
| B | 995 mm |
| C | 655 mm |
| D | 730 mm |
| E | 580 mm |
| F | 420 mm |
| G | 570 mm |
| PESO / WEIGHT | 13 Kg |

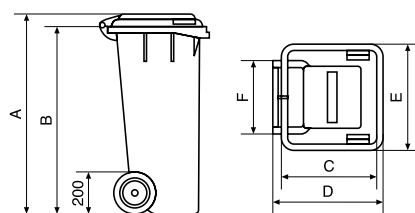

PRODOTTI IN MATERIALE RICICLABILE



1/ 240

Anello fermasacco per bidone bicolore 240 l
240 l bin liners bags



95/ 240

Sacchetti immondizia per bidone raccolta differenziata 120 l
240 l bin liners bags

Adesivi in dotazione (non applicati)
Stickers supplied (not applied)

1/120/5
120 litri

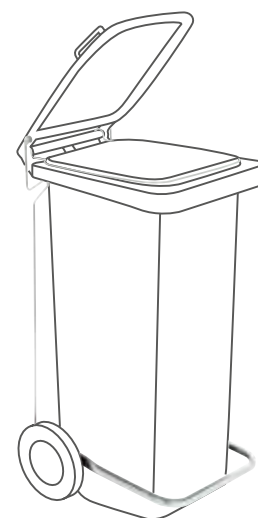

2404

Kit pedale + anello per bidone 240 l
240 l bin pedal and ring



GRIGIO-GIALLO
(GRB-GIA)



GRIGIO-VERDE
(GRB-VES)



GRIGIO-BLU
(GRB-BLB)



GRIGIO-ROSSO
(GRB-ROB)



SERRATURA GRAVITAZIONALE per bidoni carrellati 120/240 l

Il sistema a serratura gravitazionale consente allo stesso tempo:

- l'apertura e la chiusura del coperchio del bidone solamente al possessore della chiave;
- lo svuotamento del bidone da parte degli addetti alla raccolta dei rifiuti anche con serratura chiusa in quanto l'apertura del contenitore avviene in automatico una volta raggiunta una certa inclinazione (>90°) in fase di svuotamento e la chiusura viene ripristinata una volta che il contenitore viene riportato in posizione.

Il sistema rende inoltre possibile aprire il bidone dall'interno anche con serratura chiusa (per situazioni di emergenza) e non consente l'apertura accidentale del bidone in caso di rovesciamento, urti e/o atti di vandalismo.

Il kit è formato da:

- un cupolotto con serratura integrata da montare esternamente sul coperchio;
- un elemento con gancio da collocare sulla parte interna del coperchio;
- un corpo inferiore da installare nella parte interna della vasca;
- due chiavi per aprire/chiusure la serratura;
- le dime per individuare la posizione dei fori e consentire il montaggio del sistema.

The gravitational lock system allows at the same time:

- the opening and closing of the lid of the bin only to the holder of the key;
- the emptying of the bin by the waste collectors even with the lock closed as the opening of the container takes place automatically once a certain inclination (>90°) is reached during the emptying phase and the closure is restored once the container is returned to position.

The system also makes it possible to open the bin from the inside even with the lock closed (for emergency situations) and does not allow accidental opening of the bin in case of overturning, collisions and / or vandalism.

The kit consists of:

- a dome with integrated lock to be mounted externally on the lid;
- an element with a hook to be placed on the inside of the lid;
- a lower body to be installed in the internal part of the tank;
- two keys to open / close the lock;
- the templates to identify the position of the holes to allow to assembly the kit on the bin.



PULIZIA & RACCOLTA DIFFERENZIATA

Cleaning & waste collection

BIDONI CARRELLATI

360 l

Bidone carrellato 360 litri a due ruote per la raccolta differenziata.

Prodotto realizzato in HDPE (polietilene alta densità) 100% riciclabile, stabilizzato UV per utilizzo in ambienti esterni. Capacità di carico max 160 kg Predisposto per presa frontale a pettine a norma DIN. Dotato di due ruote in gomma diametro 200 mm alloggiabili in due distinte posizioni per un'agile movimentazione e stabilità. Grande maneggevolezza, maniglie ergonomiche, bordi e spigoli arrotondati. Coperchio con apertura a libro e bordo anti infiltrazione, sede per alloggiamento microchip, elevata resistenza meccanica ed agli agenti chimici, facile da pulire e sanificare. Disponibile in 5 colori.

Versione bicolore con bidone di colore grigio e coperchi in 4 colori differenti.

Two-wheeled 360 liter mobile waste bin for differential refuse collection.

Product made of 100% recyclable HDPE (high density polyethylene), UV stabilized for outdoor use. Max load capacity 160 kg. Prepared for DIN standard frontal socket. Equipped with two 200 mm diameter rubber wheels that can be housed in two distinct positions to move the bin in an easy way and have great stability. Easy handling, ergonomic handles, rounded corners and edges. Lid with book opening and anti-infiltration edge, seat for microchip housing, high mechanical and chemical resistance, easy to clean and sanitize.

Available in 5 colors.

Bicolore available with grey body and lid in 4 different colors.

| | |
|---------------|---------|
| A | 1099 |
| B | 1015 |
| C | 880 |
| D | 596 |
| PESO / WEIGHT | 15,5 Kg |

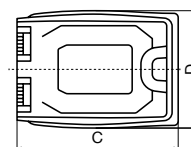
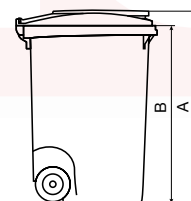

1/360/5
360 litri

TÜV Rheinland[®]
UNI EN 840
Certificato
Certified



● GRIGIO BIDONE (GRB)

● GIALLO (GIA)

● ROSSO BIDONE (ROB)

● VERDE BIDONE (VEB)

● BLU BIDONE (BLB)

● GRIGIO-GIALLO (GRB-GIA)

● GRIGIO-ROSSO (GRB-ROB)

● GRIGIO-VERDE (GRB-VEB)

● GRIGIO-BLU (GRB-BLB)





CASSONETTI 4 RUOTE 660 l

Cassonetto carrellato 4 ruote capacità 660 litri con coperchio piano. Prodotto realizzato in HDPE (polietilene alta densità) 100% riciclabile stabilizzato UV per utilizzo in ambienti esterni.

Capacità di carico max 310 kg. Predisposto per presa frontale a pettine a norma DIN, dotato di quattro ruote girevoli (due delle quali con freno) con battistrada in gomma diametro 200. Grande maneggevolezza, assenza di bordi taglienti e spigoli smussati.

Dotato di maniglie ergonomiche per la movimentazione, tappo sul fondo per una corretta pulizia e sanificazione.

Coperchio piano con apertura a libro ed impugnatura a labbro e bordo anti infiltrazione, sede per alloggiamento microchip.

Elevata resistenza meccanica ed agli agenti chimici.

Disponibile in 4 colori.

Disponibile versione bicolore con vasca di colore grigio e coperchi in 3 colori differenti.

Four-wheeled 660 liter mobile waste bin for differential refuse collection with flat lid. Product made of 100% recyclable HDPE (high density polyethylene), UV stabilized for outdoor use. Max load capacity 310 kg. Prepared for DIN standard frontal socket, equipped with four 200 mm diameter rubber caster wheels (two of them with braking system). Easy handling, ergonomic handles, rounded corners and edges. Equipped with ergonomic handles for handling, cap on the bottom for proper cleaning and sanitization. Flat lid with book opening and lip handle and anti-infiltration edge, seat for microchip housing. High mechanical and chemical resistance.

Available in 4 colors.

Bicolor available with grey body and lid in 3 different colors.

PULIZIA & RACCOLTA DIFFERENZIATA

*Cleaning & waste
collection*



UNI EN 840
Certificato
Certified



1/660/5
660 litri

●
GRIGIO BIDONE
(GRB)

●
GIALLO
(GIA)

●
VERDE BIDONE
(VEB)

●
BLU BIDONE
(BLB)

CASSONETTI 4 RUOTE BICOLORE

660 l

| | |
|---------------|-------|
| A | 778 |
| B | 1228 |
| C | 1105 |
| D | 1370 |
| E | 1270 |
| F | 1200 |
| G | 836 |
| PESO / WEIGHT | 40 Kg |

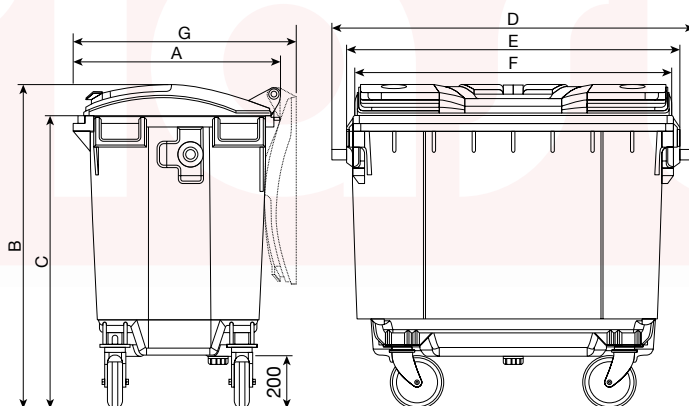

TÜV Rheinland®

UNI EN 840
Certificato
Certified



6604

Kit pedale per cassonetto 660 l
660 l bin pedal



1/660/5
660 litri

GRIGIO-GIALLO
(GRB-GIA)

GRIGIO-VERDE
(GRB-VEB)

GRIGIO-BLU
(GRB-BLB)





CASSONETTI 4 RUOTE 770 l

Cassonetto carrellato 4 ruote capacità 770 litri con coperchio piano. Prodotto realizzato in HDPE (polietilene alta densità) 100% riciclabile stabilizzato UV per utilizzo in ambienti esterni.

Capacità di carico max 360 kg. Predisposto per presa frontale a pettine a norma DIN, dotato di quattro ruote girevoli (due delle quali con freno) con battistrada in gomma diametro 200. Grande maneggevolezza, assenza di bordi taglienti e spigoli smussati. Dotato di maniglie ergonomiche per la movimentazione, tappo sul fondo per una corretta pulizia e sanificazione. Coperchio piano con apertura a libro ed impugnatura a labbro e bordo anti infiltrazione. Elevata resistenza meccanica ed agli agenti chimici. Disponibile in 4 colori.

Disponibile versione bicolor con vasca di colore grigio e coperchi in 3 colori differenti.

Four-wheeled 770 liter mobile waste bin for differential refuse collection with flat lid. Product made of 100% recyclable HDPE (high density polyethylene), UV stabilized for outdoor use. Max load capacity 360 kg. Prepared for DIN standard frontal socket, equipped with four 200 mm diameter rubber caster wheels (two of them with braking system). Easy handling, ergonomic handles, rounded corners and edges. Equipped with ergonomic handles for handling, cap on the bottom for proper cleaning and sanitization. Flat lid with book opening and lip handle and anti-infiltration edge, seat for microchip housing. High mechanical and chemical resistance.

Available in 4 colors.

Bicolor available with grey body and lid in 3 different colors.

PULIZIA & RACCOLTA DIFFERENZIATA

*Cleaning & waste
collection*



TÜV Rheinland®

UNI EN 840
Certificato
Certified



1/770/5
770 litri

●
GRIGIO BIDONE
(GRB)

●
GIALLO
(GIA)

●
VERDE BIDONE
(VEB)

●
BLU BIDONE
(BLB)

CASSONETTI 4 RUOTE BICOLORE

770 l

| | |
|---------------|-------|
| A | 778 |
| B | 1365 |
| C | 1243 |
| D | 1370 |
| E | 1270 |
| F | 1200 |
| G | 836 |
| PESO / WEIGHT | 43 Kg |

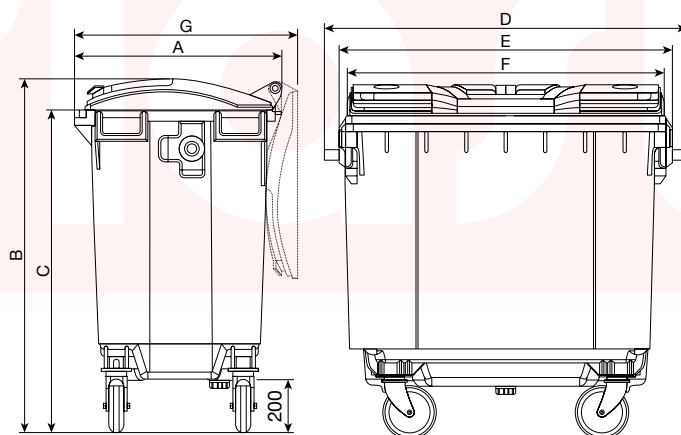

TÜV Rheinland®

UNI EN 840
Certificato
Certified



7704

Kit pedale per cassonetto 770 l
770 l bin pedal



1/770/5
770 litri

GRIGIO-GIALLO
(GRB-GIA)

GRIGIO-VERDE
(GRB-VEB)

GRIGIO-BLU
(GRB-BLB)





CASSONETTI 4 RUOTE 1100 l

Cassonetto carrellato 4 ruote capacità 1100 litri con coperchio piano. Prodotto realizzato in HDPE (polietilene alta densità) 100% riciclabile stabilizzato UV per utilizzo in ambienti esterni.

Capacità di carico max 510 kg. Predisposto per presa frontale a pettine a norma DIN, dotato di quattro ruote girevoli (due delle quali con freno) con battistrada in gomma diametro 200. Grande maneggevolezza, assenza di bordi taglienti e spigoli smussati. Dotato di maniglie ergonomiche per la movimentazione, tappo sul fondo per una corretta pulizia e sanificazione. Coperchio piano con apertura a libro ed impugnatura a labbro e bordo anti infiltrazione. Elevata resistenza meccanica ed agli agenti chimici.

Disponibile in 4 colori.

Disponibile versione bicolor con vasca di colore grigio e coperchi in 3 colori differenti.

Four-wheeled 1100 liter mobile waste bin for differential refuse collection with flat lid. Product made of 100% recyclable HDPE (high density polyethylene), UV stabilized for outdoor use. Max load capacity 510 kg. Prepared for DIN standard frontal socket, equipped with four 200 mm diameter rubber caster wheels (two of them with braking system). Easy handling, ergonomic handles, rounded corners and edges. Equipped with ergonomic handles for handling, cap on the bottom for proper cleaning and sanitization. Flat lid with book opening and lip handle and anti-infiltration edge, seat for microchip housing. High mechanical and chemical resistance.

Available in 4 colors.

Bicolor available with grey body and lid in 3 different colors.

PULIZIA & RACCOLTA DIFFERENZIATA

*Cleaning & waste
collection*



TÜV Rheinland[®]

UNI EN 840
Certificato
Certified



1/1100/5
1100 litri

●
GRIGIO BIDONE
(GRB)

●
GIALLO
(GIA)

●
VERDE BIDONE
(VEB)

●
BLU BIDONE
(BLB)

CASSONETTI 4 RUOTE BICOLORE

1100 l

| | |
|---------------|-------|
| A | 1070 |
| B | 1344 |
| C | 1280 |
| D | 1370 |
| E | 1270 |
| F | 1200 |
| G | 1127 |
| PESO / WEIGHT | 50 Kg |

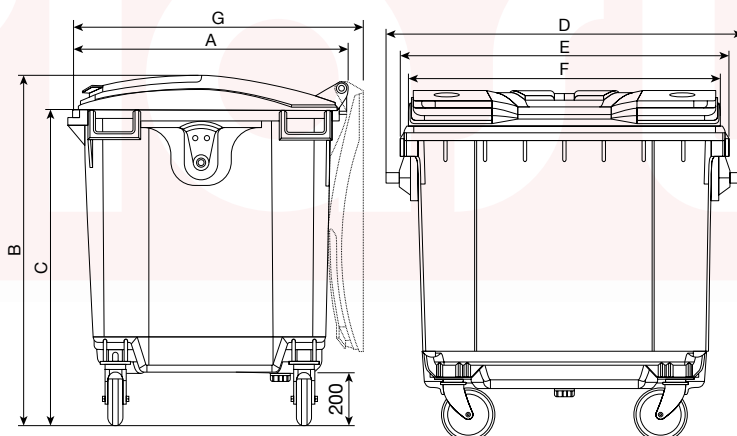

TÜV Rheinland®

UNI EN 840
Certificato
Certified



11004

Kit pedale per cassonetto 1100 l
1100 l bin pedal



1/1100/5
1100 litri

GRIGIO-GIALLO
(GRB-GIA)

GRIGIO-VERDE
(GRB-VEB)

GRIGIO-BLU
(GRB-BLB)





BIDONE 80

80 l

Pratico bidone portarifiuti da 80 litri con due ruote e coperchio ad apertura 120°. Design moderno e funzionale. Realizzato in copolimero di polipropilene (PP). Adatto per utilizzi interni ed esterni. Leggero e di facile trasporto, resistente agli agenti atmosferici e chimici. Ideale per la raccolta differenziata. Totale assenza di spigoli vivi e con superfici lisce e di facile pulizia. Dotato di 4 ganci fissi fermasacco. Disponibile con fondo grigio e coperchi in 4 colori differenti oppure totalmente di colore bianco per utilizzi in ambienti specifici (HACCP, enti, ospedali ecc). Disponibile separatamente il kit pedale alzacoperchio.

| | |
|---------------|----------|
| 80 | 80 litri |
| A | 450 mm |
| B | 500 mm |
| C | 500 mm |
| D | 780 mm |
| E | 120 mm |
| PESO / WEIGHT | 3 Kg |

Two-wheeled serviceable 80 liter waste bin with 120° opening lid. Modern and functional design. Made of 100% recyclable polypropylene (PP). Suitable for indoor and outdoor use. Light and easy to transport, resistant to atmospheric and chemical agents. Ideal for differential refuse collection. Total absence of sharp edges and with smooth and easy to clean surfaces. Equipped with 4 fixed hooks to lock the bag. Available with gray body and lids in 4 different colors or totally white for use in specific environments (HACCP, institutional offices, hospitals etc). Lid opener pedal kit available separately.

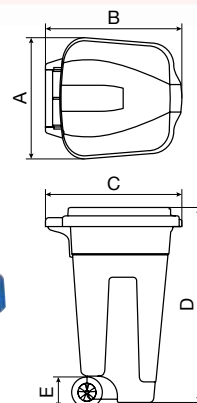

PULIZIA & RACCOLTA DIFFERENZIATA

Cleaning & waste collection



Maniglia ergonomica e rinforzata per facilitarne il trasporto
Ergonomic and thicker handle for an easy handling



Dotato di 4 ganci fermasacco
With 4 hooks keep bag



Bidone facilmente impilabile con ruote montate
Easy stackable bins with preassembled wheels



Alta scorrevolezza delle ruote antisdrucchio ed estrema maneggevolezza nello spostamento
No-slip wheels and easy to manoeuvre



Ruote e assali premontati, meno errori e più facilità di spedizione con bloccaggio delle ruote per l'utilizzo finale
Wheels and axles already assembled, fast delivery and less problems. Wheels with brake for final use

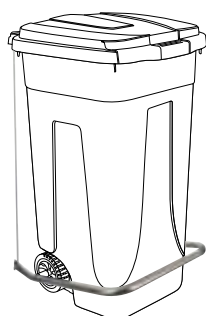

804
Kit pedale
Pedal kit



80
80 litri



95/80
Sacchetti immondizia per bidone raccolta differenziata 80 l
80 l bin liners bags

plastica
seconda vita
MIX ECO

Tranne (BIL) / Except for (BIL)



GRIGIO-GIALLO (GRB-GIA)

GRIGIO-ROSSO (GRB-ROB)

GRIGIO-VERDE (GRB-VES)

GRIGIO-BLU (GRB-BLB)

BIANCO (BIL)



PRODOTTI IN MATERIALE RICICLABILE

BIDONE 100

100 l

Pratico bidone portarifiuti da 100 litri con due ruote e coperchio ad apertura 270° e chiusura a clip. Design moderno e funzionale. Realizzato in copolimero di polipropilene (PP). Adatto per utilizzi interni ed esterni. Leggero e di facile trasporto, resistente agli agenti atmosferici e chimici. Ideale per la raccolta differenziata. Totale assenza di spigoli vivi e con superfici lisce e di facile pulizia. Dotato di 4 ganci fissi fermasacco. Disponibile con fondo grigio e coperchi in 4 colori differenti.

Two-wheeled serviceable 100 liter waste bin with 270° opening lid. Modern and functional design. Made of 100% recyclable polypropylene (PP). Suitable for indoor and outdoor use. Light and easy to transport, resistant to atmospheric and chemical agents. Ideal for differential refuse collection. Total absence of sharp edges and with smooth and easy to clean surfaces. Equipped with 4 fixed hooks to lock the bag. Available with grey body and lids in 4 different colors.

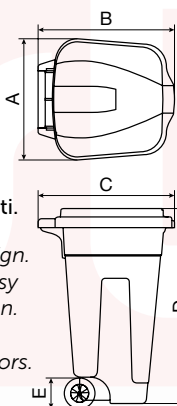

| | |
|---------------|-----------|
| 100 | 100 litri |
| A | 490 mm |
| B | 540 mm |
| C | 540 mm |
| D | 850 mm |
| E | 143 mm |
| PESO / WEIGHT | 3,70 Kg |



Coperchi con chiusura a clip
Clip down lid



Maniglia ergonomica e rinforzata per facilitarne il trasporto
Ergonomic and thicker handle for an easy handling



Dotato di 4 ganci fermasacco
With 4 hooks keep bag



Bidone facilmente impilabile con ruote montate
Easy stackable bins with preassembled wheels



100
100 litri

plastica
seconda vita
MIX ECO



Alta scorrevolezza delle ruote antiscivolo ed estrema maneggevolezza nello spostamento
No-slip wheels and easy to manoeuvre

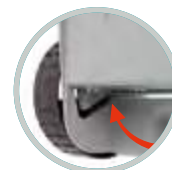

Ruote e assali premontati, meno errori e più facilità di spedizione con bloccaggio delle ruote per l'utilizzo finale
Wheels and axles already assembled, fast delivery and less problems. Wheels with brake for final use



95/120
Sacchetti immondizia per bidone raccolta differenziata 120 l
120 l bin liners bags



GRIGIO-GIALLO
(GRB-GIA)



GRIGIO-ROSSO
(GRB-ROB)



GRIGIO-VERDE
(GRB-VES)



GRIGIO-BLU
(GRB-BLB)



PRODOTTI IN
MATERIALE
RICICLABILE



BIDONE 100 PUSH 100 l

Pratico bidone portarifiuti da 100 litri con due ruote e coperchio a campana con pratica apertura basculante. Design moderno e funzionale. Realizzato in copolimero di polipropilene (PP). Adatto per utilizzi interni ed esterni. Leggero e di facile trasporto, resistente agli agenti atmosferici e chimici. Ideale per la raccolta differenziata. Totale assenza di spigoli vivi e con superfici lisce e di facile pulizia. Dotato di 4 ganci fissi fermasacco. Disponibile in colore grigio e sportellino basculante in 4 colori differenti.

Two-wheeled serviceable 100 liter waste bin with bell-shaped lid and handy tilting opening. Modern and functional design. Made of 100% recyclable polypropylene (PP). Suitable for indoor and outdoor use. Light and easy to transport, resistant to atmospheric and chemical agents. Perfect for differential refuse collection. Total absence of sharp edges and with smooth and easy to clean surfaces. Equipped with 4 fixed hooks to lock the bag. Available with grey body and tilting window in 4 different colors.

| 100 PUSH | 100 litri |
|---------------|-----------|
| A | 490 mm |
| B | 540 mm |
| C | 540 mm |
| D | 950 mm |
| E | 143 mm |
| PESO / WEIGHT | 3,70 Kg |

PULIZIA & RACCOLTA DIFFERENZIATA

Cleaning & waste collection



Maniglia ergonomica e rinforzata per facilitarne il trasporto
Ergonomic and thicker handle for an easy handling



Dotato di 4 ganci fermasacco
With 4 hooks keep bag



Campana basculante per bidone Cento Push
Flap lid for bin Cento Push



Bidone facilmente impilabile con ruote montate
Easy stackable bins with preassembled wheels



Alta scorrevolezza delle ruote antisdrucchiolo ed estrema maneggevolezza nello spostamento
No-slip wheels and easy to manoeuvre



Ruote e assali premontati, meno errori e più facilità di spedizione con bloccaggio delle ruote per l'utilizzo finale
Wheels and axles already assembled, fast delivery and less problems. Wheels with brake for final use

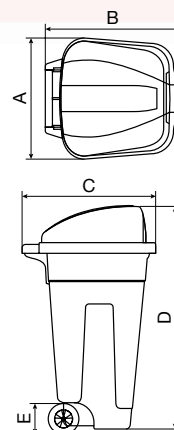

95/1
Sacchetti immondizia per bidone raccolta differenziata 100 l
100 l bin liners bags

plastica
seconda vita
MIX ECO

100 PUSH
100 litri



GRIGIO-GIALLO
(GRB-GIA)



GRIGIO-ROSSO
(GRB-ROB)



GRIGIO-VERDE
(GRB-VES)



GRIGIO-BLU
(GRB-BLB)

BIDONE NELLO 80 l

Nello è un bidone di nuova concezione che si distingue innanzitutto per il felice connubio estetico-funzionale evidenziato da linee morbide e ben raccordate tra loro.

Dotato di ruote e comoda maniglia per spostamenti veloci e sicuri, pedale di apertura e anello reggisacco.

Si adatta agli ambienti di lavoro professionale e hobbistico, come officine, garage, laboratori industriali.

151-GRN completo di n. 8 tappi in 4 colori per una corretta identificazione della differenziata.

Nello is a new-concept bin, which combines beauty and functionality stressed by an elegant and harmonic design. Equipped with wheels and a handle for fast and safe movings, an opening pedal and bags holder ring. It is suitable for internal use in all locations (workshops, garages, studios). 151-GRN includes a set of nr 8 cups in 4 different colours for a right waste separation and identification.

| | |
|---------------|----------|
| NELLO | 80 litri |
| A | 650 mm |
| B | 810 mm |
| C | 400 mm |
| PESO / WEIGHT | 6,20 Kg |

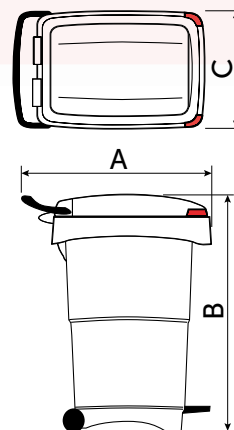

95/80
Sacchetti immondizia
per bidone NELLO 80 l
Bin liners for NELLO 80 l



151
80 litri

plastica
seconda vita
MIX ECO

Tranne (BIL) / Except for (BIL)



GRIGIO
(GRN)



BIANCO
(BIL)



Apertura a pedale
Opening pedal





TRESPOLO 110 l

Trespolo portasacchetto da 110 litri con anello.
Realizzato in HDPE (polietilene alta densità) 100% riciclabile. Economico, pratico e versatile, leggero e di semplice utilizzo particolarmente adatto per la raccolta differenziata per interni ed esterni. Disponibile nei colori verde o grigio scuro oppure nella versione bicolor con corpo grigio e coperchio in 4 colori differenti.

Trestle bag holder 110 liter with locking bag ring. Made of 100% recyclable HDPE (high density polyethylene). Cheap, practical and adaptable, light and easy to use, particularly suitable for indoor and outdoor differential refuse collection. Available in green or dark gray color or in the bicolor version with grey body and lid in 4 different colors.

PULIZIA & RACCOLTA DIFFERENZIATA

*Cleaning & waste
collection*



| | |
|---------------|---------|
| A | 380 |
| B | 850 |
| C | 510 |
| PESO / WEIGHT | 2,43 Kg |

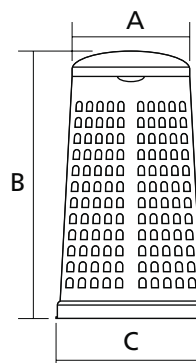

plastica

seconda vita
MIX ECO

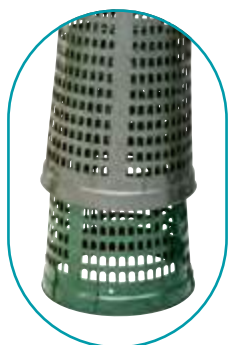

69/110
110 litri



95/120
Sacchetti immondizia per TRESPOLO
Bin liners TRESPOLO waste bin





PULIZIA & RACCOLTA DIFFERENZIATA

Cleaning & waste collection



100/4-GR
Completo di 4 secchi
Complete with 4 buckets



KIT 100/4-MIX
Ordinabile anche separatamente
To be ordered also separately

ECO-AIR 4

Mobiletto ventilato in lamiera elettrosaldata verniciato a forno in polvere epossidica a due ribalte sovrapposte contenenti due secchi da 20 l ognuna.

A - Aerazione, ventilazione: il mobiletto è dotato di griglie di aerazione che hanno lo scopo di favorire la fermentazione dei residui organici e di smaltire l'odore sgradevole.

B - Robusti piedi, sollevato da terra per una agevole pulizia.

Cabinet in electro welded plate painted by epoxy powder oven. with two superposed tilt drawers including two 20 l buckets each.

***A** - Airing/ ventilation: the cabinet is equipped with grates that help fermentation of the organic refusal and discharge the unpleasant odours.*

***B** - Strong feet, lifted base to allow an easy cleaning.*

| | |
|---------------|--------|
| A | 100 cm |
| B | 43 cm |
| C | 65 cm |
| D | 100 cm |
| E | 25 cm |
| PESO / WEIGHT | 21 Kg |

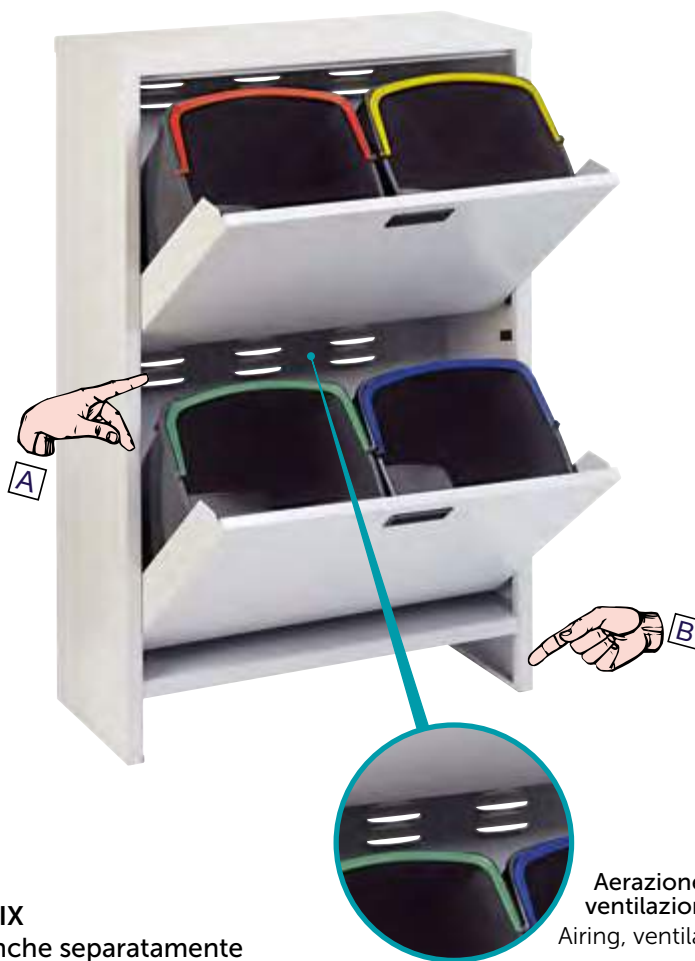
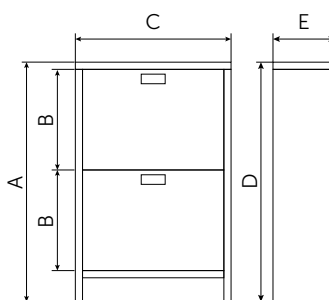

Aerazione,
ventilazione
Airing, ventilation

BIDONE 91

60 - 80 - 100 l

Bidone con
coperchio

Bin with hinged lid

| art. 91 | Ø | H | capacità |
|---------|---------|---------|----------|
| 91/060 | Ø 45 cm | H 60 cm | 60 l |
| 91/080 | Ø 45 cm | H 74 cm | 80 l |
| 91/100 | Ø 45 cm | H 88 cm | 100 l |

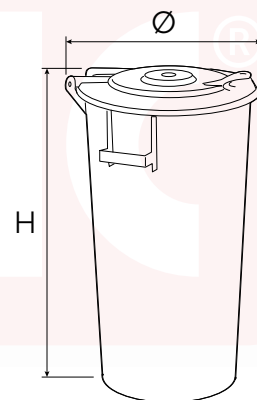

95/1

Sacchetti immondizia
per bidone con cerniera.
Bin liners for hinged bin.



91/060
60 litri



91/080
80 litri



91/100
100 litri

●
NERO
(NER)



PRODOTTI IN
MATERIALE
RICICLABILE



BIDONI INDUSTRIALI

da 35 a 200 l

| art. | Capacità Capacity | h | Ø |
|--------|----------------------|----|----|
| 8/0035 | 35 l. | 41 | 39 |
| 8/0050 | 50 l. | 47 | 46 |
| 8/0075 | 75 l. | 57 | 48 |
| 8/0100 | 100 l. | 67 | 52 |
| 8/0150 | 150 l. | 71 | 62 |
| 8/0200 | 200 l. | 81 | 67 |



Art. 19/1

GRIGIO
(GR)

Carrello per bidone industriale 75-100 l.
 A seconda del lato in cui vengono montate le ruote
 è adatto al trasporto di bidoni da 75 litri o da 100 litri.
75-100 l. Industrial bin trolley
You can fit the wheels in both sizes, one size is suitable
for the 75 litres industrial bin and one for the 100 litres bin.

PULIZIA & RACCOLTA DIFFERENZIATA

Cleaning & waste collection

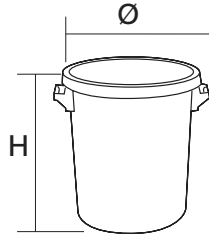

BIDONI INDUSTRIALI

da 35 a 300 l

| art. | Capacità Capacity | h | Ø |
|--------|----------------------|----|----|
| 92/035 | 35 l. | 41 | 39 |
| 92/050 | 50 l. | 47 | 46 |
| 92/075 | 75 l. | 57 | 48 |
| 92/100 | 100 l. | 67 | 52 |
| 92/150 | 150 l. | 71 | 62 |
| 92/200 | 200 l. | 81 | 67 |
| 92/300 | 300 l. | 89 | 76 |

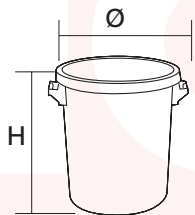

Art. 19/1

GRIGIO
(GR)



Carrello per bidone industriale 75-100 l.
A seconda del lato in cui vengono montate le ruote è adatto al trasporto di bidoni da 75 litri o da 100 litri.

75-100 l. Industrial bin trolley
You can fit the wheels in both sizes, one size is suitable for the 75 litres industrial bin and one for the 100 litres bin.



92/035



92/050



92/075



92/100



PP 27/035



PP 27/050



PP 27/075



PP 27/100



92/150



92/200



92/300



27/150



27/200



27/300



PULIZIA

Cestino gettacarta
Waste-paper basket

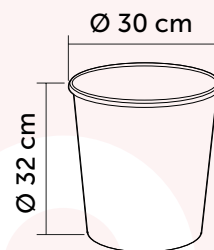

●
GRIGIO
(GRI)



107/30

●
NERO
(NER)



●
BRUNO BIDONE
(BRR)

PULIZIA & RACCOLTA DIFFERENZIATA

Cleaning & waste collection



Alzaimmondizia con manico
Standing dustpan

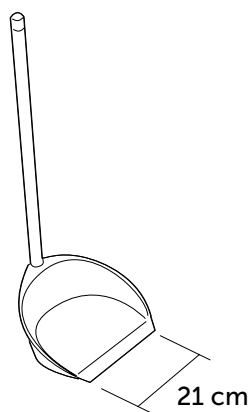

●
BRUNO BIDONE
(BRR)

90



Paletta polvere
Dustpan

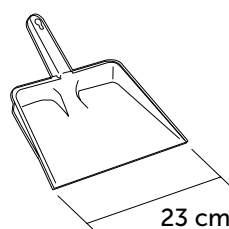

●
BRUNO BIDONE
(BRR)

124/23



BIDONE DUSTY

25 l

Pratico bidone portarifiuti da 25 litri, con coperchio dotato di chiusura a clip. Realizzato in polipropilene (PP) riciclabile 100%. Design moderno, si adatta a tutti gli ambienti. Disponibile con bidone di colore grigio e 4 varianti di colore per il coperchio utili per la raccolta differenziata.

Practical 25 liter waste bin, with lid equipped with clip closures. Made of 100% recyclable polypropylene (PP). Modern design, adapts to all environments. Available with gray bin and 4 color variations for the lid useful for recycling.

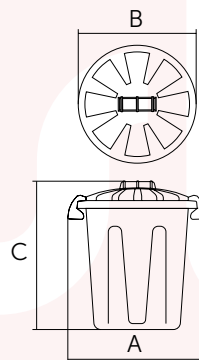

| | |
|---------------|-----------------------|
| DUSTY | 25 litri [®] |
| A | 400 mm |
| B | 360 mm |
| C | 450 mm |
| PESO / WEIGHT | 0,95 Kg |



plastica
seconda vita
MIX ECO



105/25
25 litri

GRIGIO-GIALLO
(GRB-GIA)

GRIGIO-ROSSO
(GRB-ROB)

GRIGIO-VERDE
(GRB-VES)

GRIGIO-BLU
(GRB-BLB)





PORTARIFIUTI ECOLOGY 25/35 l

Pratico e robusto contenitore portarifiuti, ideale per la raccolta differenziata urbana e domestica si adatta a tutti gli ambienti per il suo design moderno e funzionale, dotato di sportello basculante a becco e coperchio con meccanismo antirandagismo e comodo maniglione ergonomico con blocco verticale.

Realizzato in compound di Polipropilene (PP) riciclabile al 100%, resistente agli agenti atmosferici, chimici ai raggi UV per utilizzo intensivo all'esterno. Totale assenza di spigoli, superfici lisce per una agevole pulizia e sanificazione, impilabile e inseribile, predisposizione per RFID, presa sul fondo per un facile svuotamento, coperchio con cerniere rinforzate per una apertura a 270°. Disponibile nelle misure da 25 lt e 35 lt., con contenitore e coperchio di colore Grigio e con sportello e maniglione di presa in 4 varianti di colore.

Sturdy and functional waste bin, ideal for urban and domestic use. Its stylish and functional design makes it perfect for all environments. This bin is provided with a hinged and anti stray lid, ergonomic handle with vertical locking. The bin is made from polypropylene compound, 100% recyclable, weather, chemical and UV resistant allowing it to be safely used outside. No edges, smooth surfaces, easy to clean and disinfect, stackable and nestable, RFID technology predisposed. Reinforced hinges to allow a 270° opening, easy emptying system thanks to ergonomic grips on the bottom. Available sizes 25 and 35 l, grey bin with flap and handle in 4 colors.

PULIZIA & RACCOLTA DIFFERENZIATA

*Cleaning & waste
collection*

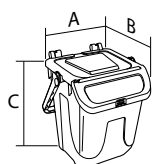

| ECOLOGY 25 | lt 25 |
|-------------|--------|
| A | 370 |
| B | 370 |
| C | 410 |
| PESO/WEIGHT | 1,3 Kg |

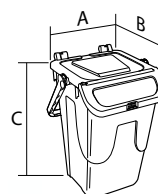

| ECOLOGY 35 | lt 35 |
|-------------|--------|
| A | 370 |
| B | 370 |
| C | 520 |
| PESO/WEIGHT | 1,5 Kg |



●●
GRIGIO-BLU
(GRB-BLB)



●●
GRIGIO-BRUNO
(GRB-BRB)



●●
GRIGIO-GIALLO
(GRB-GIA)



●●
GRIGIO-VERDE
(GRB-VES)

plastica

seconda vita

MIX ECO

Impilabile e inseribile.

Preso sul fondo per un facile svuotamento, coperchio con cerniere rinforzate per una apertura a 270°.

Dotato di sportello basculante a becco e coperchio con meccanismo antirandagismo e maniglione con blocco verticale.

Stackable and nestable.

Easy emptying system thanks to ergonomic grips on the bottom, reinforced hinges to allow a 270° opening.

Provided with a hinged and anti stray lid, ergonomic handle with vertical locking.



11/35
35 litri

11/25
25 litri



●●
GRIGIO-BLU
(GRB-BLB)



●●
GRIGIO-BRUNO
(GRB-BRB)



●●
GRIGIO-GIALLO
(GRB-GIA)



●●
GRIGIO-VERDE
(GRB-VES)





CASSE



MASTELLI CANTINA



BIDONI CANTINA



ALTRO ENOLOGIA

ENOLOGIA & AGRICOLTURA

Enology & Agriculture

108



**CANTINETTA
E CESTELLI**

109



**MASTELLI
AGRICOLTURA**

110



INNAFFIATOI



CASSE

inseribili e sovrapponibili

| art. | L | H | P | Capacità Capacity |
|--------|----|----|----|----------------------|
| 131/50 | 55 | 31 | 43 | 50 l |
| 131/65 | 63 | 34 | 44 | 65 l |
| 133/50 | 57 | 3 | 43 | - |
| 133/65 | 65 | 3 | 45 | - |

**ENOLOGIA &
AGRICOLTURA**
Enology & Agriculture

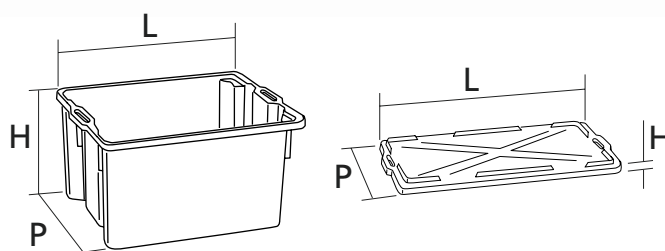



131/50



131/65



133/50 - 133/65
PP COPERCHIO PER CASSA
CRATE LID



PRODOTTI IN
MATERIALE
RICICLABILE



MASTELLI CANTINA

| art. | H | Ø | Capacità Capacity | |
|--------|----|-----|----------------------|-----------|
| 2/0110 | 30 | 80 | 110 l | sottotino |
| 2/0275 | 35 | 110 | 275 l | sottotino |
| 2/0225 | 54 | 86 | 225 l | |
| 2/0350 | 71 | 95 | 350 l | |
| 2/0500 | 82 | 104 | 500 l | |
| 2/0700 | 90 | 115 | 700 l | |
| 2/1000 | 95 | 134 | 1000 l | |

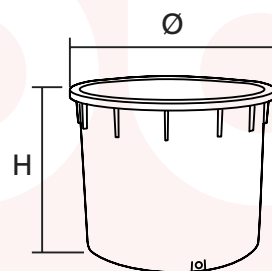

**ENOLOGIA &
AGRICOLTURA**
Enology & Agriculture



17

**Filtro svinarola per
rubinetto 1"**

Wine filter 1" tap



20/ 1

Rubinetto 1"

Tap 1"



150

**Maniglia per
mastello**

Handle tub



il Plastic®



2/0110



2/0275



2/0225



2/0350



2/0500



2/0700



2/1000



32/500



32/700



PRODOTTI IN
MATERIALE
RICICLABILE



BIDONI CANTINA

| art. | Capacità Capacity | H | Ø |
|--------|----------------------|----|----|
| 13/150 | 150 l | 71 | 62 |
| 13/200 | 200 l | 81 | 67 |
| 13/300 | 300 l | 89 | 76 |

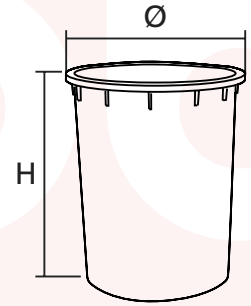

**ENOLOGIA &
AGRICOLTURA**
Enology & Agriculture



20/3/4

Rubinetto 3/ 4"

Tap 3/ 4"

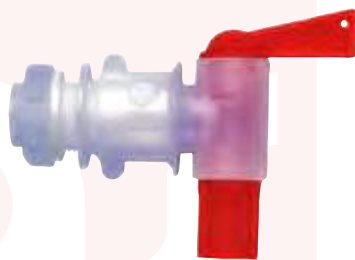

13/150



13/200



13/300



32/150



32/200



32/300



PRODOTTI IN
MATERIALE
RICICLABILE



**ENOLOGIA &
AGRICOLTURA**
Enology & Agriculture



CESTO TONDO con manico

ART. 53

Cesto tondo con
manico in plastica - 15 l

*Round basket with
plastic handle - 15 l*



53

ARAGOSTA (ARA)

ART. 53/F

Cesto tondo con
manico in ferro - 15 l

*Round basket with
iron handle - 15 l*

CESTO OVALE con manico

ART. 74

Cesto ovale con
manico in plastica - 20 l

*Oval basket with
plastic handle - 20 l*



74

ARAGOSTA (ARA)

MASTELLO

2 manici

| art. | H | Ø | Capacità Capacity |
|------|----|----|----------------------|
| 126 | 45 | 49 | 50 l |

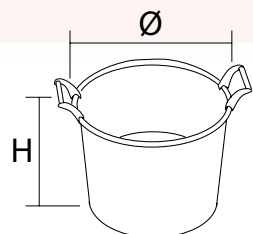

126

●
ARAGOSTA (ARA)

TIRA OLIO

Art. 63

Tira olio - 0,5 l

Oil-siphon - 0,5 l



63

○
NEUTRO (N)



PRODOTTI IN
MATERIALE
RICICLABILE



**ENOLOGIA &
AGRICOLTURA**
Enology & Agriculture



CANTINETTA 6 posti

Six bottle holder

SOVRAPPONIBILE



67



BRUNO RAME (BRR)



PRODOTTI IN
MATERIALE
RICICLABILE

CESTELLO PORTA BOTTIGLIE 6 posti

*Stackable six
bottle crate*



23



ROSSO (ROM)



VERDE (VET)



PRODOTTI IN
MATERIALE
RICICLABILE

CESTELLO PORTA BOTTIGLIONI 4 posti

*Stackable four
bottle crate*



24



ROSSO (ROM)



VERDE (VET)



PRODOTTI IN
MATERIALE
RICICLABILE

MASTELLI AGRICOLTURA

| art. | H | Ø | Capacità Capacity |
|--------|----|-----|----------------------|
| 8/0110 | 30 | 80 | 110 l |
| 8/0225 | 54 | 86 | 225 l |
| 8/0350 | 71 | 95 | 350 l |
| 8/0500 | 82 | 104 | 500 l |
| 8/0700 | 90 | 115 | 700 l |
| 8/1000 | 95 | 134 | 1000 l |

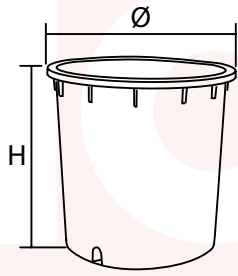

17

Filtro svinarola per
rubinetto 1"
Wine filter 1" tap



PP

20/ 1

Rubinetto 1"
Tap 1"



PP

150

Maniglia per
mastello
Handle tub



8/0110



8/0225



8/0350



8/0500



8/0700



8/1000



77/500



77/700

NERO (NER)





INNAFFIATOI

Gamma di inaffiatoi estremamente robusti e dal design tradizionale, con riserva d'acqua e comoda impugnatura.

Range of extremely robust watering cans with a traditional design, water reserve and comfortable handle.

ENOLOGIA & AGRICOLTURA

Enology & Agriculture



| art. | Capacità Capacity |
|-------|----------------------|
| 87/02 | 2 l |
| 87/04 | 4 l |
| 87/08 | 8 l |
| 87/12 | 12 l |
| 87/16 | 16 l |



Diffusore a doccia
incluso nei modelli:
4 - 8 - 12 - 16





87/02



87/04



87/08



87/12



87/16



114



TANICHE

116



**TANICHE
BENZINA**

117



**FUSTINI A
BOTTICELLA**

118



**BIDONI COLLO
LARGO**

119



**BIDONI
INDUSTRIALI PER
ALIMENTI**

122



**CASSE
ALIMENTARI
E FOODBOX**

TRASPORTO LIQUIDI & INDUSTRIA ALIMENTARE

Liquid transport & food industry

125



**CASSETTE 60 X 40
E LIGHTBOX**

127



MASTELLI

128



IMBUTI

130



SECCHI

131



CARAFFE

132



SESSOLE



TANICHE

| art. | Capacità Capacity |
|-------|----------------------|
| 73/10 | 10 l |
| 73/20 | 20 l |
| 61 | 15 - 3,5 l |

TRASPORTO LIQUIDI & INDUSTRIA ALIMENTARE

*Liquid transport &
food industry*



Tanica due usi *Tank double use*



61

Tanica con rubinetto *Tank with tap*



73/10

73/20

Tanica Tank

| art. | Capacità Capacity |
|---------|----------------------|
| 125/01 | 1 l |
| 125/02 | 2 l |
| 125/03 | 3 l |
| 125/05 | 5 l |
| *125/10 | 10 l |
| *125/15 | 15 l |
| *125/20 | 20 l |
| *125/25 | 25 l |
| *125/30 | 30 l |



* Versatore telescopico incluso
* Telescopic pourer included



125/01



125/02



125/03



125/05



125/10



125/15



125/20



125/25



125/30



PRODOTTI IN
MATERIALE
RICICLABILE



TANICHE BENZINA

Taniche per combustibili liquidi in polietilene alta densità rinforzato. Dotate di travasatore flessibile avvitabile. Tappo di chiusura ermetico con anello di sicurezza. Omologazione UN a norma direttive CEE. Con indicatore di livello

Jerry can for liquid fuel in reinforced high density polyethylene. Provided with flexible screw pouring spout. Sealed cap with safety ring. All size are of UN approved standard and specification. With level indicator

| art. | Capacità Capacity |
|--------|----------------------|
| 115/05 | 5 l |
| 115/10 | 10 l |



TRASPORTO LIQUIDI & INDUSTRIA ALIMENTARE

*Liquid transport &
food industry*



115/05

115/10

Indicatore di livello

V-stripe



Beccuccio flessibile

Pouring spout



VERDE SCURO (VES)



PRODOTTI IN
MATERIALE
RICICLABILE

FUSTINI A BOTTICELLA

| art. | Capacità Capacity | h | Ø |
|--------|----------------------|----|----|
| 97/005 | 5 l | 28 | 18 |
| 97/010 | 10 l | 32 | 23 |
| 97/015 | 15 l | 37 | 27 |
| 97/020 | 20 l | 41 | 29 |
| 97/025 | 25 l | 44 | 32 |
| 97/050 | 50 l | 56 | 39 |
| 97/100 | 100 l | 71 | 49 |



ACCESSORI ACCESSORIES



20/14
Rubinetto 1/4"
Tap 1/4"

PP



97/005



97/010



97/015



97/020



97/025



97/050



97/100

○
NEUTRO (N)



PRODOTTI IN
MATERIALE
RICICLABILE



BIDONI COLLO LARGO

| art. | Capacità Capacity | H | Ø A | Ø B |
|-------|----------------------|------|------|-----|
| 78/02 | 2 l | 21 | 14 | 10 |
| 78/05 | 5 l | 31 | 16 | 10 |
| 78/10 | 10 l | 35,5 | 21,5 | 11 |

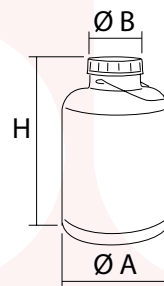

TRASPORTO LIQUIDI & INDUSTRIA ALIMENTARE

*Liquid transport &
food industry*



78/02



78/05



78/10

NEUTRO (N)



BIDONI INDUSTRIALI con chiusura ad anello

Contenitore con chiusura ad anello in metallo completo di guarnizione.

Articolo non a tenuta stagna

Metal ring closure bin complete of gasket. Not leak-proof.

| art. | Capacità Capacity | H | Ø |
|--------|----------------------|----|----|
| 18/075 | 75 l | 57 | 48 |
| 18/100 | 100 l | 67 | 52 |

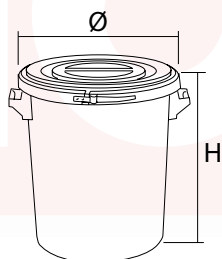

18/075



18/100



19/01

GRIGIO (GR)

Art. 19/1

Carrello per bidone industriale 75-100 l A seconda del lato in cui vengono montate le ruote è adatto al trasporto di bidoni da 75 litri o da 100 litri.

75-100 l Industrial bin trolley. You can fit the wheels in both sizes, one size is suitable for the 75 litres industrial bin and one for the 100 litres bin.

PP

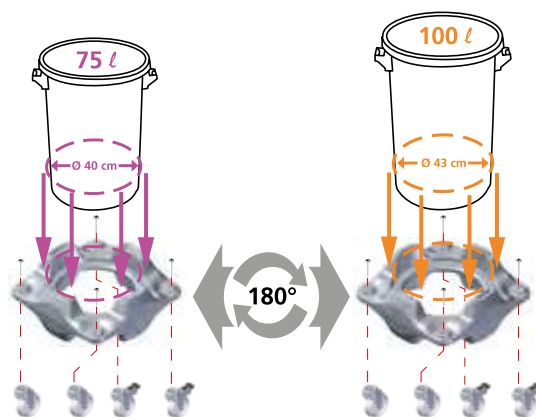

NEUTRO (N)



PRODOTTI IN
MATERIALE
RICICLABILE



BIDONI INDUSTRIALI

da 35 a 300 l

| art. | Capacità Capacity | H | Ø |
|--------|----------------------|----|----|
| 19/035 | 35 l | 41 | 39 |
| 19/050 | 50 l | 47 | 46 |
| 19/075 | 75 l | 57 | 48 |
| 19/100 | 100 l | 67 | 52 |
| 19/150 | 150 l | 71 | 62 |
| 19/200 | 200 l | 81 | 67 |
| 19/300 | 300 l | 89 | 76 |

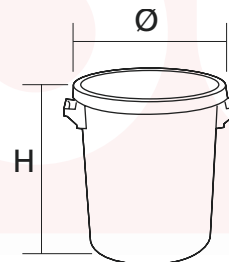

TRASPORTO LIQUIDI & INDUSTRIA ALIMENTARE

Liquid transport &
food industry



PP



19/01

GRIGIO (GR)

Art. 19/1

Carrello per bidone industriale 75-100 l
A seconda del lato in cui vengono montate le
ruote è adatto al trasporto di bidoni da 75 litri
o da 100 litri.

75-100 l. Industrial bin trolley

You can fit the wheels in both sizes, one size is
suitable for the 75 litres industrial bin and one for the
100 litres bin.

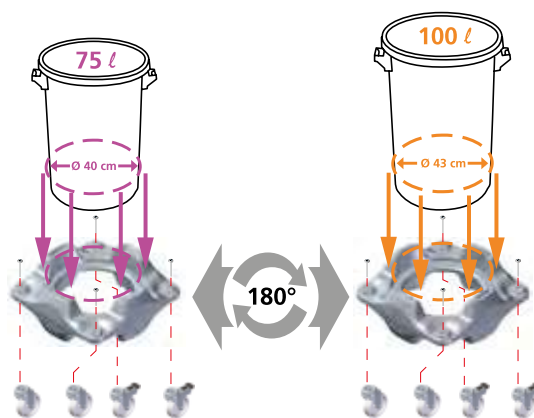



19/035



19/050



19/075



19/100



PP 59/035



PP 59/050



PP 59/075



PP 59/100



19/150



19/200



19/300



59/150



59/200



59/300

○
NEUTRO (N)



PRODOTTI IN
MATERIALE
RICICLABILE



CASSE

inseribili e sovrapponibili

| art. | L | H | P | Capacità Capacity |
|--------|----|-----|----|----------------------|
| 131/50 | 55 | 31 | 43 | 50 l |
| 131/65 | 63 | 34 | 44 | 65 l |
| 131/90 | 72 | 36 | 47 | 90 l |
| 132/50 | 55 | 31 | 43 | 50 l |
| 132/65 | 63 | 34 | 44 | 65 l |
| 133/50 | 57 | 3 | 43 | - |
| 133/65 | 65 | 3 | 45 | - |
| 133/90 | 75 | 3,5 | 47 | - |

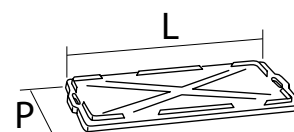
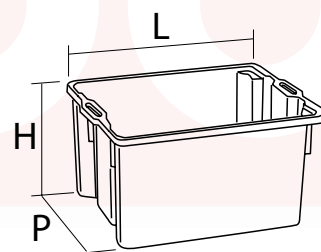

TRASPORTO LIQUIDI & INDUSTRIA ALIMENTARE

*Liquid transport &
food industry*





131/50

131/65

131/90



132/50

132/65



133/50 - 133/65 - 133/90
Coperchio per casse 131 - 132
Lid for crates 131 - 132



PRODOTTI IN
MATERIALE
RICICLABILE



FOOD BOX

inseribili e sovrapponibili

| art. | L | H | P | Capacità Capacity |
|--------|----|----|----|----------------------|
| 143/20 | 38 | 30 | 28 | 20 l |
| 143/40 | 58 | 26 | 38 | 40 l |
| 143/60 | 58 | 38 | 38 | 60 l |

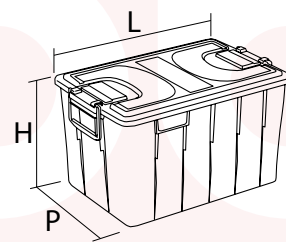

TRASPORTO LIQUIDI & INDUSTRIA ALIMENTARE

*Liquid transport &
food industry*

Casse grandi e piccole tra loro sovrapponibili per facilitarne il trasporto, coperchio in dotazione con chiusura

Large and small crate can be put one on the other to facilitate transport, cover with enclosed closures



143/20

143/40



143/60



Porta targhetta
Tag holder

○
BIANCO (BIM)

○
TRASPARENTE (TS)



PRODOTTI IN
MATERIALE
RICICLABILE

CASSETTE

60x40

| art. | L | H | P |
|------|----|----|----|
| 4407 | 60 | 7 | 40 |
| 4410 | 60 | 10 | 40 |
| 4413 | 60 | 13 | 40 |
| 4400 | 60 | - | 40 |
| 5800 | 62 | 14 | 42 |

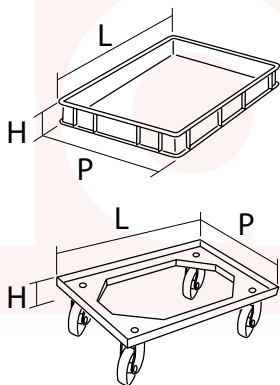

4407



4410



4413



PP

4400
Coperchio per casse
Crate lid



5800
Carrello per cassetta
Crate trolley

ABS



ROSSO (ROB)





LIGHTBOX

| art. | L x P x H Esterne External | L x P x H Interne Internal | Capacità Capacity |
|------|----------------------------------|----------------------------------|----------------------|
| 5900 | 655 x 435 x 30 | – | – |
| 5908 | 650 x 425 x 85 | 600 x 400 x 80 | 19 l |
| 5911 | 650 x 425 x 115 | 600 x 400 x 110 | 25 l |

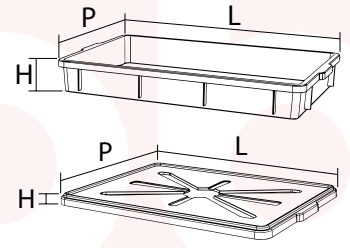

TRASPORTO LIQUIDI & INDUSTRIA ALIMENTARE

Liquid transport &
food industry



impilabili



temperatura
esercizio



5908



5911



5900

○
TRASPARENTE (TS)



○
BIANCO (BIM)

○
BIANCO (BIM)



MASTELLI

| art. | H | Ø | Capacità Capacity | |
|--------|----|-----|----------------------|-----------|
| 7/0110 | 30 | 80 | 110 l | sottotino |
| 7/0275 | 35 | 110 | 275 l | sottotino |
| 7/0225 | 54 | 86 | 225 l | |
| 7/0350 | 71 | 95 | 350 l | |
| 7/0500 | 82 | 104 | 500 l | |
| 7/0700 | 90 | 115 | 700 l | |
| 7/1000 | 95 | 134 | 1000 l | |

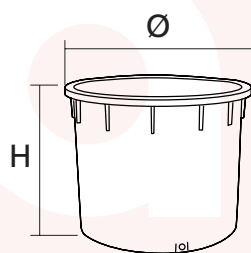

17

Filtro svinarola per
rubinetto 1"

Wine filter 1" tap

PP



20/ 1

Rubinetto 1"

Tap 1"

PP



150

Maniglia per
mastello

Handle tub



7/0110



7/0275



7/0225



7/0350



7/0500



7/0700



7/1000



59/500



59/700



NEUTRO (N)



PRODOTTI IN
MATERIALE
RICICLABILE



Colalatte con filtro

Mix colander with stainer



35
Ø 27 cm.

○
BIANCO (BIM)

TRASPORTO LIQUIDI & INDUSTRIA ALIMENTARE

*Liquid transport &
food industry*



Imbuto con tubo flessibile e filtro

Funnel with flexible tube and filter



10/26
Ø 26 cm.

○
BIANCO (BIM)

Imbuto Funnel



54

Ø 6 - 8 - 10 - 12 - 14 - 16 - 18 - 20 - 22 - 24 - 26 - 30 cm.

○
BIANCO (BIM)

Imbuto con porta filtro Funnel with filter-support



43

Ø 22 - 26 - 30 - 35 cm.



ART. 147/10
Filtro Ø 10 cm.
per imbuto Ø 22 cm.
Filter Ø 10 cm.
for funnel Ø 22 cm.



ART. 147/12
Filtro Ø 12 cm.
per imbuto Ø 26 - 30 - 35 cm.
Filter Ø 12 cm.
for funnel Ø 26 - 30 - 35 cm.

○
BIANCO (BIM)



PRODOTTI IN
MATERIALE
RICICLABILE



SECCHIO INDUSTRIALE GRADUATO

Graduated industrial bucket

| art. | Capacità Capacity |
|-------|----------------------|
| 65/12 | 12 l |
| 65/15 | 15 l |
| 65/18 | 18 l |

TRASPORTO LIQUIDI & INDUSTRIA ALIMENTARE

*Liquid transport &
food industry*



65/12



65/15



65/18

○
NEUTRO (N)

●
GRIGIO (GRI)

CARAFFA GRADUATA

Graduated jug

| art. | Capacità Capacity |
|--------|----------------------|
| 6/0500 | 0,5 l |
| 6/1000 | 1 l |
| 6/2000 | 2 l |
| 6/3000 | 3 l |
| 6/5000 | 5 l |



6/0500



6/1000



6/2000



6/3000



6/5000

○
BIANCO (BIM)

○
TRASPARENTE (TS)



PRODOTTI IN
MATERIALE
RICICLABILE



Sessole Spoon

| art. | cm. |
|--------|-----|
| 136/19 | 19 |
| 136/24 | 24 |
| 136/29 | 29 |
| 136/34 | 34 |
| 136/38 | 38 |
| 136/42 | 42 |
| 31 | 43 |

TRASPORTO LIQUIDI & INDUSTRIA ALIMENTARE

*Liquid transport &
food industry*



SESSOLA RETTANGOLARE
RECTANGULAR LARGE-SPOON



31

il Plastic®



136/19



136/24



136/29



136/34



136/38



136/42



PRODOTTI IN
MATERIALE
RICICLABILE



**CATINI
BAGNI QUADRI**



**BAGNI OVALI
BAGNI TONDI**



**MASTELLI
3 MANICI**

CASALINGHI

Household



SECCHI



SCOLAPASTA



INSALATIERE



BAGNI QUADRI

| art. | L | H | P | Ø |
|-------|----|----|----|---|
| 21/30 | 30 | 15 | 30 | - |
| 21/32 | 32 | 15 | 32 | - |
| 21/34 | 34 | 17 | 34 | - |

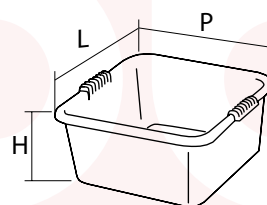

CASALINGHI
Household

Square basin



21/30



21/32



21/34

○
NEUTRO (N)

●
AZZURRO (AZP)

CATINI

| art. | Ø | art. | Ø |
|-------|----|-------|----|
| 52/24 | 24 | 52/32 | 32 |
| 52/26 | 26 | 52/34 | 34 |
| 52/28 | 28 | 52/36 | 36 |
| 52/30 | 30 | 52/38 | 38 |

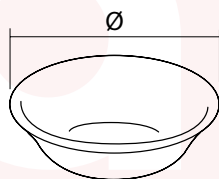

Basin



52/24



52/26



52/28



52/30



52/32



52/34



52/36



52/38



BIANCO (BIM)



PRODOTTI IN
MATERIALE
RICICLABILE



BAGNI TONDI

| art. | Ø | art. | Ø |
|-------|----|-------|----|
| 41/32 | 32 | 41/40 | 40 |
| 41/34 | 34 | 41/45 | 45 |
| 41/36 | 36 | 41/50 | 50 |

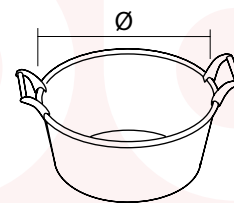

CASALINGHI
Household

Round basin



41/32

41/34

41/36



41/40

41/45



41/50

○
NEUTRO (N)

●
AZZURRO (AZP)

BAGNI OVALI

| art. | Ø | art. | Ø |
|-------|----|-------|----|
| 47/45 | 45 | 47/65 | 65 |
| 47/50 | 50 | 47/70 | 70 |
| 47/55 | 55 | 47/80 | 80 |
| 47/60 | 60 | | |

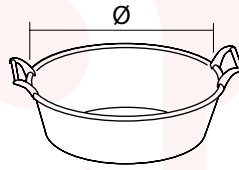

Oval basin



47/45



47/50



47/55



47/60



47/65



47/70



47/80



NEUTRO (N)



AZZURRO (AZP)



SOLO PER
PRODOTTI
NEUTRI (N)



PRODOTTI IN
MATERIALE
RICICLABILE



MASTELLI

3 manici

| art. | Ø |
|-------|----|
| 82/45 | 45 |
| 82/50 | 50 |
| 82/55 | 55 |

| art. | Ø |
|-------|----|
| 82/60 | 60 |
| 82/65 | 65 |
| 82/70 | 70 |

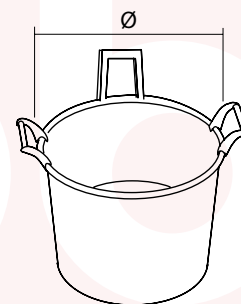

CASALINGHI
Household

MASTELLO 3 MANICI
THREE-HANDLE TUB

82 AZP

—

82 N



il Plastic®



82/45



82/50



82/55



82/60



82/65



82/70



SECCHIO

| art. | Capacità Capacity |
|-------|----------------------|
| 39/7 | 7 l |
| 39/9 | 9 l |
| 39/12 | 12 l |
| 39/15 | 15 l |

CASALINGHI
Household

Secchio normale graduato
Graduated bucket



39/07



39/09



39/12



39/15

○
NEUTRO (N)

●
AZZURRO (AZP)

SECCHIO

Plastic®

| art. | Capacità Capacity |
|-------|----------------------|
| 42/9 | 9 l |
| 42/12 | 12 l |
| 42/15 | 15 l |

Secchio con becco graduato
Graduated bucket with pouring lip



42/09



42/12



42/15

○
NEUTRO (N)

●
AZZURRO (AZP)



SOLO PER
PRODOTTI
NEUTRI (N)



PRODOTTI IN
MATERIALE
RICICLABILE



SCOLAPASTA

| art. | Ø |
|--------|----|
| 109/22 | 22 |
| 109/26 | 26 |
| 109/30 | 30 |
| 12 | 18 |

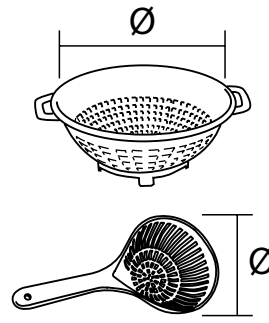

CASALINGHI
Household

Scolapasta
Colander



○
BIANCO (BIM)

INSALATIERA

| art. | Ø | art. | Ø |
|-------|----|-------|----|
| 50/16 | 16 | 50/26 | 26 |
| 50/18 | 18 | 50/28 | 28 |
| 50/20 | 20 | 50/30 | 30 |
| 50/22 | 22 | 50/32 | 32 |
| 50/24 | 24 | 50/34 | 34 |

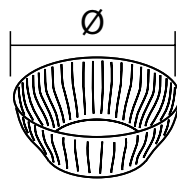

Insalatiera *Salad bowl*



50/16



50/18



50/20



50/22



50/24



50/26



50/28



50/30



50/32



50/34

○
BIANCO (BIM)



PRODOTTI IN
MATERIALE
RICICLABILE

PERSONALIZZAZIONI







PRIVATE LABEL

Disponibilità a fornire su richiesta loghi personalizzati e/o colori non presenti a catalogo.
Prodotti in materiale autoestinguente a norma UL 94.
Quantità e prezzi da concordare.

*For special requests of non-standard colours.
Items made of self-extinguishing materials as by UL 94.
Prices and quantities have to be agreed.*



Materiali / Material

| | |
|---|--|
|  | polietilene tereftalato / <i>polyethylene terephthalate</i> |
|  | polipropilene / <i>polypropylene</i> |
|  | polistirolo / <i>polystyrene</i> |
|  | polietilene ad alta densità / <i>high density polyethylene</i> |
|  | polietilene a bassa densità / <i>low density polyethylene</i> |
|  | acrilonitrile-butadiene-stirene / <i>acrylonitrile-butadiene-styrene</i> |

Simboli / Symbols



PRODOTTI IN MATERIALE
RICICLABILE



PRODOTTI IN MATERIALE
PER USO ALIMENTARE

tutti gli articoli contrassegnati dal simbolo alimentare, sono conformi alle direttive ce n. 1935/2004 e regolamenti d.m. n. 34 del 21-03-73
all items marked with the food use logo, are in conformity with n. 1935/2004 and d.m. n. 34/21-03-73

Colori / Colors

| | |
|--|--|
| ARA = aragosta / <i>bright orange</i> | GC = grigio chiaro / <i>light grey</i> |
| AZP = azzurro politene / <i>polythene blue</i> | GS = grigio scuro / <i>anthracite grey</i> |
| BIL = bianco latte / <i>milky white</i> | GRN = grigio-nero / <i>grey-black</i> |
| BIM = bianco / <i>white</i> | N = neutro / <i>neutral</i> |
| BL = blu / <i>blue</i> | NE = nero / <i>black</i> |
| BLB = blu bidone / <i>bin blue</i> | NER = nero / <i>black</i> |
| BRB = bruno bidone / <i>bin brown</i> | RO = rosso / <i>red</i> |
| BRR = bruno rame / <i>copper brown</i> | ROB = rosso bidone / <i>bin red</i> |
| GI = giallo / <i>yellow</i> | ROM = rosso / <i>red</i> |
| GIA = giallo / <i>yellow</i> | TR = trasparente / <i>transparent</i> |
| GR = grigio / <i>grey</i> | TS = bianco trasparente / <i>transparent white</i> |
| GRB = grigio bidone / <i>bin grey</i> | VE = verde / <i>green</i> |
| GRB-BLB = grigio-blu / <i>grey-blue</i> | VEB = verde bidone / <i>bin green</i> |
| GRB-GIA = grigio-giallo / <i>grey-yellow</i> | VEI = verde industriale / <i>industrial green</i> |
| GRB-ROB = grigio-rosso / <i>grey-red</i> | VES = verde scuro / <i>dark green</i> |
| GRB-VES = grigio-verde / <i>grey-green</i> | VIN = vinaccia / <i>grape red</i> |
| GRI = grigio / <i>grey</i> | VET = verde / <i>green</i> |

Misure / Size

L - P - H

Misure massimo ingombro dell'articolo.
Maximun external dimensions of the article.

l - p - h

Misura utile interna del singolo cassetto.
Practical internal dimension of single drawer.

SERVIZIO CLIENTI

CUSTOMER SERVICE

• MOBIL PLASTIC offre un completo servizio di informazioni attraverso il suo Ufficio Commerciale e Marketing. Un contatto diretto, per informazioni e richieste di cataloghi, si può avere anche attraverso la e-mail info@mobilplastic.it e l'accesso al sito Internet www.mobilplastic.it

• MOBIL PLASTIC offers a complete information service by means of the Sales and Marketing Department. You can contact the company directly for information and catalogues by e-mail info@mobilplastic.it and Internet Web site www.mobilplastic.it

servizio
clienti



Tel. 0039 0384 674692

e-mail



info@mobilplastic.it



internet

www.mobilplastic.it



INFORMAZIONI

INFORMATION

I colori riprodotti hanno valore indicativo.

Le misure indicate hanno una tolleranza di ± 2 mm.

I colori ed i modelli potranno subire variazioni senza preavviso.

È possibile fornire per quantità e prezzi da stabilire: prodotti in colori fuori catalogo; prodotti in materiale autoestinguente a norma UL 94; prodotti personalizzati.

Per impieghi diversi da quelli tradizionali si suggerisce di chiedere esplicite indicazioni.

The reproduced colours have an indicative value.

The above-cited dimensions have a tolerance of ± 2 mm.

Colours and models can be subject to change without warning.

It is possible to supply the following in individually arranged quantities and prices: Goods in colours not in catalogue; Goods in self extinguishing materials conforming to the norms UL 94; Personalized products.

For specific and different uses other than those listed it is suggested to contact the company directly.

Mobil Plastic®



www.mobilplastic.it



MOBIL PLASTIC S.P.A. - Via Robbio, 31 - 27030 CONFENZA (PV)
Tel. 0384.674692 (4 linee r. a.) - Fax: 0384.674696 - E-Mail: info@mobilplastic.it